

SEREN

INDUSTRIAL POWER SYSTEMS INC.

RX01/LX01 SERIES RADIO FREQUENCY POWER SUPPLY OPERATOR'S MANUAL

Revision: 1.02
Standard Configuration

Document Number 6100220000

SEREN Industrial Power Systems, Inc.
1717 Gallagher Drive
Vineland, New Jersey, 08360
U.S.A

Telephone: 856-205-1131
Fax: 856-205-1141
E-mail: info@serenips.com

Copyright © 2003-2005 Seren IPS Inc.

Introduction

Thank you for acquiring your new SEREN IPS product. Seren Radio Frequency Power Supplies are designed to provide the best value, ease of operation, and reliability for plasma processing systems. This manual covers specifications, installation, and operation of the Seren IPS Inc. RX01 and LX01 Series RF Power Supplies.

Information

To get answers for any questions you might have regarding your plasma or processing system, please contact your system vendor first. Your system vendor knows the intimate details of how your equipment interfaces and operates with the RF Power Supply and can efficiently resolve system related problems.

For questions directly related to the RF Power Supply, you may call us, Monday through Friday, 8:00am to 5:00pm, United States Eastern Time, at:

1-856-205-1131

Service

For RF Power Supplies purchased with a processing system, or covered under a service contract from your system vendor, please contact the system vendor to arrange for service.

For after-market or end user customers, a SEREN IPS customer service representative will arrange for service. Call us, Monday through Friday, 8:00am to 5:00pm, United States Eastern Time, at: **1-856-205-1131**

Please note: Equipment returned to us without prior authorization or without a Return Materials Authorization (RMA) number visible on the outside of the package will be refused.

How to Contact Us

Our address, telephone, and fax numbers are listed below.

SEREN Industrial Power Systems, Inc.
1717 Gallagher Drive
Vineland, New Jersey, 08360 U.S.A.

Telephone: 856-205-1131
Fax: 856-205-1141

Proprietary Information Notice

This document contains information proprietary to SEREN IPS Inc. This document shall not be reproduced or its contents disclosed without the written permission of SEREN IPS Inc. This notice shall appear in all copies.

TABLE OF CONTENTS

Safety Notes	1
RF Power Supply Model Features	3
 Installation	 4
Mounting	4
Supplied Accessories	4
Ventilation	4
 Connection to a Water Cooling System	 5
Connecting to Water Inlet/Outlet Ports	5
Coolant Water Temperature and Flow Rate	6
Coolant Water Supply Lines	6
Solenoid Water Valve Installation	7
 RF Output Connection	 7
Connection to AC Mains	8
System Interfacing	9
 Front Panel Controls and Display.....	 10
 Operation.....	 12
Front Panel Operation.....	12
 Analog Interface Operation.....	 16
 Serial Interface Operation.....	 18
Serial Command Reference	20
Serial Command Details	26
 Configuring Programmable Parameters	 41

TABLE OF CONTENTS

Programmable Parameter Reference	41
Programmable Parameter Details.....	47
Rear Panel Controls and Connections.....	64
R101, R101MKII, R301, R301MKII, L301, L301MKII Rear Panel	64
R601, L601, R1001, L1001 Rear Panel	64
R1001W Rear Panel	65
R2001, R2001H, R3001, L2001, L2001H, L3001 Rear Panel	66
R5001 Rear Panel	66
RF Output Connector	67
Power Inlet or Power Cord	67
Mains Circuit Breaker	68
DCP Connector (R101, R101MKII, L101MKII, R301, R301MKII L301, L301MKII Models only)	68
CEX OUT Connector	68
CEX IN Connector	69
Fan Exhaust	69
Analog Interface Connector.....	70
Analog Interface Pin List	71
Typical Interface Circuits	78
Serial Interface Connector.....	81
Serial Interface Connector Pin List	81
Serial Interface Wiring	82
Equipotential Bonding Terminal	83
Valve Connector	84
Valve Connector Pin List	84

TABLE OF CONTENTS

Coolant Water IN Port	85
Coolant Water OUT Port	85
Typical Interface Connections.....	86
Basic Analog Interfacing.....	86
External Feedback with Probe Inverter Option (Models R101, R101MKII, L101MKII, R301, R301MKII, L301, L301MKII only)	87
Typical System Configuration	89
Maintenance.....	90
Problem Solving.....	91
Technical Data	95
RF Power Supply Identification	95
Specifications: R101	96
Specifications: R101MKII	102
Specifications: R301	105
Specifications: R301MKII.....	108
Specifications: L301	111
Specifications: L301MKII	114
Specifications: R601	117
Specifications: L601	120
Specifications: R1001	123
Specifications: R1001W	126
Specifications: L1001	130
Specifications: R2001	133
Specifications: R2001H	137
Specifications: L2001	141
Specifications: L2001H	145
Specifications: R3001	149

TABLE OF CONTENTS

Specifications: L3001	153
Specifications: R5001	157
Physical Dimensions: R101, R101MKII, R301, R301MKII, L301, L301MKII	161
Physical Dimensions: R601, L601, R1001, R1001W, L1001	163
Physical Dimensions: R2001, R2001H, L2001, L2001H, R3001, L3001	165
Physical Dimensions: R5001	167
Agency Compliance Information	169
Declaration Of Conformity (CE)	
Models R101, R101MKII, L101, R301, R301MKII, L301, L301MKII, R601, L601, R1001, L1001	169
Declaration Of Conformity (CE)	
Models R2001, R2001H, L2001, L2001H, R3001, L3001	170
Semiconductor Equipment and Materials International (SEMI)	171
SEREN 1 Year Limited Warranty.....	172
Obtaining Service for your RF Power Supply.....	172
Glossary of Terms.....	173
Revision History.....	175

Safety Notes

Seren IPS Inc. RF Power Supplies have been designed and tested to meet strict safety requirements. These include independent lab examination and approval, and compliance to established standards. Please read the following instructions carefully before operating the RF Power Supply and refer to them as needed to ensure the continued safe operation of the RF Power Supply.

Follow all warnings and instructions marked on or supplied with the product.

Symbology:

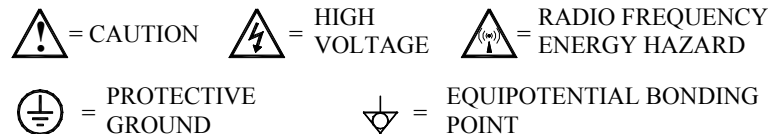

Unplug or disconnect this equipment from the power source before cleaning or re-configuring the AC mains voltage.

Do not use this equipment near water, wet locations, or outdoors.

Do not place this equipment on an unstable cart, stand, or table. The RF Power Supply may fall, causing personal injury or damage to the RF Power Supply .

This product is equipped with a power cord and grounding type plug. This is a safety feature. To avoid electric shock, this unit must be connected to the power source in compliance with the National Electrical Code ANSI C1 and/or any other codes applicable to the user. Improper installation may result in a shock or fire hazard.

It is the responsibility of the installer to provide a proper protective ground from the RF Power Supply to earth ground, in accordance with local and national electrical codes, and any other codes applicable to the user.

The RF Power Supply should be operated from the type of power source indicated by the ratings plate. If you are not sure of the type of power available, consult an electrician or your local power company.

The power supply cord and plug is the disconnect device for this equipment. If the plug is removed from the cord and the power cord is hard wired to the power source, it is the responsibility of the installer to provide a disconnect device.

Do not allow anything to rest on the power cord or interconnecting cables. Do not locate the RF Power Supply where persons will step on the power or interconnecting cables.

Slots and Openings in the equipment's chassis are provided for ventilation. To ensure reliable operation of the RF Power Supply, these openings must not be blocked, covered, or restricted. Restricting the air inlets or exhaust will cause the unit to overheat. Sustained over temperature conditions may degrade or damage the unit.

Never push objects of any kind into the slots and openings of the RF Power Supply's enclosure. They may touch dangerous voltage points or short out parts, which could result in a fire or electric shock.

Never spill liquid of any kind on or into the RF Power Supply.

Never remove covers or guards that require a tool for removal. There are no operator serviceable areas within these covers. Refer servicing to qualified service personnel.



CAUTION!



**ELECTRICAL SHOCK HAZARD PRESENT
INSIDE UNIT, AT THE RF OUTPUT
CONNECTOR, AND AT THE MAINS INPUT
CONNECTOR.
DO NOT REMOVE COVERS.
REFER SERVICING TO QUALIFIED SERVICE
PERSONNEL.**

Radio Frequency Power Supply Features

Seren IPS Inc. RF Power Supplies are intended for use with radio frequency plasma processing systems and radio frequency processing applications.

The RX01 and LX01-Series RF Power Supplies provide a level-controlled radio frequency power output. Available frequencies are 100-460KHz (LX01 Series), 1.7-2.1MHz, and 13.56MHz (RX01-Series) at power levels up to 5000 Watts. The RX01 and LX01-Series RF Power Supplies feature operator-accessible controls, a visual display of power supply status, and control interfaces to the user's processing system. Other RF Power Supply features are listed below:

- Packages: R/L101, R/L301, R/L101MKII, R/L301MKII: ½ Rack, 3U High Package
 R/L601, R/L1001: ½ Rack, 4U High Package
 R/L2001, R/L3001: 19" Rack, 4U High Package
 R5001: 19" Rack, 5U High Package
- Flexible AC Mains voltage:
 - R101, R/L301: 90-140VAC or 190-264VAC, selectable via transformer taps
 - R/L101MKII: 90-140VAC or 190-264VAC, universal input, no taps to configure.
 - R/L301MKII: 90-140VAC or 190-264VAC, universal input, no taps to configure.
 - R/L601: 90-140VAC or 190-264VAC, universal input, no transformer taps to configure
 - R/L1001: 190-264VAC, no transformer taps to configure.
 - R/L2001, R/L3001, R5001: 190-264VAC, no transformer taps to configure.
- User programmable 100 to 460KHz synthesized internal frequency source (L-Series)
- User programmable 1.7MHz to 2.1MHz synthesized internal frequency source (R-Series)
- Crystal-Controlled fixed frequency (R-Series)
- Programmable Variable Frequency Tuning. (1.7-2.1MHz R-Series, L-Series Models)
- Bright, easy to read 4 Line Vacuum Fluorescent Display, capable of displaying Forward and Reflected RF Power, Control Mode, Power Supply status, and RF or DC Probe Voltage.
- Front panel controls for RF On/Off, mode selection, and programming
- Front Panel, Analog, and Serial control interfaces
- Forward Power and Load (Net) Power Leveling
- Scaleable Forward and Reflected power metering
 (requires interface connection to user's system)
- Scalable RF and DC Probe Voltage display
- Remote control operation via analog system interface connector
- Computer Control via RS-232/422/485 serial interface
- Common Exciter input and output
- Voltage Probe Inverter option available (100 Watt and 300 Watt models)
- Air Cooling (100-1000 Watt models)
- Water Cooling (models over 1000 Watts)

Installation:

Recommended mounting:

Seren IPS Inc. RF Power Supplies are designed for placement on a tabletop or on a shelf within an equipment rack, in a clean environment. The table or equipment rack must be capable of supporting the full weight of the unit.

The RF Power Supply is supplied with Rack Mounting Ears. The mounting ears are designed for securing the RF Power Supply to the equipment rack rail. The rack mounting ears ***are not*** designed to support the weight of the RF Power Supply. The user must provide a shelf within the equipment rack to support the weight of RF Power Supply. The user is responsible for providing mounting hardware. RF Power Supply weights are listed by model type in the technical specifications section of this manual.

Mounting Options for ½ -Rack RF Power supplies:

One (1) ½-rack RF Power Supply may be mounted in a 19" equipment rack with the use of an optional single rack mount kit. The user must provide a shelf within the equipment rack to support the weight of unit.

Two (2) ½-rack RF Power Supplies may be mounted in a 19" equipment rack with the use of an optional dual rack mount kit. The user must provide a shelf within the equipment rack to support the weight of two (2) ½-rack units.

Supplied Accessories:

Supplied accessories vary by model type. Supplied accessories may include power cords, rack ears, water valves, and other accessory items. Refer to the appropriate RF Power Supply model's page in the technical specifications section of this manual.

Ventilation:

All of the RX01/LX01 series RF Power Supplies require ventilation, including the water-cooled model types. The forced-air cooling requirements vary by model type. Refer to the appropriate RF Power Supply model's page in the technical specifications section of this manual for the model-specific forced air cooling requirements. If the unit is mounted in an equipment rack or other suitable enclosure, ensure there is adequate fresh (cool) air intake and an exhaust path for the rear panel fan.



Placing the RF Power Supply in an unventilated or sealed enclosure will create an "oven" effect and force the unit to shut down. Continued operation under conditions of poor ventilation may degrade or damage the RF Power Supply.

Maximum air intake temperature is +40°C

Connection To A Water Cooling System: *(Water-cooled RF Power Supplies only)*

Water-cooled RF Power Supplies requires connection to an external, user-supplied water chiller or water re-circulation system. Two (2) 3/8" N.P.T. female ports are provided on the rear panel of the unit. An external solenoid water valve is provided to prevent condensation within the RF Power Supply.

Connecting to Water Inlet/Outlet Ports:

Water-cooled RF Power Supplies use 3/8" N.P.T. (tapered), dry-seal, hexagonal female fittings for coolant water inlet and outlet port connections. Although the coolant water ports are brazed to an internal bracket or heatsink, the coolant water ports can be damaged by excessive torque when threading a fitting into the coolant water inlet and outlet ports.



Improper installation, removal, or over-tightening of water fittings will damage the water inlet/outlet ports and cause water leaks. The water leak may be internal and unobserved.

Damage to the water inlet/outlet ports and internal components resulting from improper fitting installation or removal are not covered by Seren IPS Inc. product warranty.

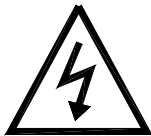

WARNING!

Improper coolant water fitting installation or removal may cause water leaks and create an electrocution hazard.

Use the methods specified below to install or remove coolant water fittings.

Water Fitting Installation Method	
Step	Action
1.	Wrap a layer of Teflon pipe sealant tape around the male threads of the fitting to be installed in the water inlet or outlet port.
2.	Thread the fitting into the water inlet or outlet port <i>by hand</i> until tight.
3.	Place a wrench on the hexagonal coolant water port. Hold the wrench steady to prevent rotation of the coolant water port.
4.	Place a second wrench on the water fitting threaded into the coolant water port in step 2.
5.	Turn the water fitting with the second wrench one-quarter (1/4) to one-half (1/2) turn clockwise to seat the fitting and create a dry seal.
6.	Apply coolant water and ensure there are no leaks at the coolant water inlet or outlet port threads.

Water Fitting Removal Method	
Step	Action
1.	Disable coolant water flow and drain the system or system segment pertaining to the RF Power Supply. Drain the supply lines connected to the RF Power Supply.
2.	Place a wrench on the hexagonal coolant water port. Hold the wrench steady to prevent rotation of the coolant water port
3.	Place a second wrench on the water fitting to be removed from the coolant water port.
4.	Turn the water fitting with the second wrench one-quarter (1/4) to one-half (1/2) turn counter-clockwise to un-seat the fitting.
5.	Unthread the fitting from the coolant water inlet or outlet port <i>by hand</i> .

Coolant Water Temperature and Flow Rate:

Coolant water inlet temperature range is +15°C to +40°C. Recommended coolant water inlet temperature range is +22°C to +28°C (to prevent condensation). Minimum coolant water flow rate varies by model type. Refer to the appropriate RF Power Supply model's page in the technical specifications section of this manual for the model-specific coolant water flow rate. Detailed coolant water specifications are located in the Technical Specifications section of this manual.

To prevent condensation within the RF Power Supply, a solenoid water valve is provided.

Coolant Water Supply Lines:

To ensure sufficient coolant water flow, the coolant water supply and return lines must have an inside diameter (I.D.) of 3/8 inch [9.52mm] or greater. Connect the water supply lines directly to the system water supply manifold.



DO NOT connect the RF Power Supply's coolant lines in series or "daisy-chain" with other water-cooled equipment. Other water-cooled equipment may have restricted water paths, resulting in insufficient water flow through the RF Power Supply.

The RF Power Supply's solenoid water valve disables the water flow through the unit when the RF output is "off" or when the AC Mains is "off". Interrupting coolant water flow to other water-cooled equipment may cause damage to that equipment.

Solenoid Water Valve Installation:

The solenoid water valve *must* be connected to the unit before connecting to the water re-circulation system and enabling AC Mains power. To prevent condensation inside the RF Power Supply, the solenoid water valve disables water flow when the RF output is “off” or when the unit’s AC Mains power is disabled.



Failure to install the solenoid water valve could allow condensation to build up within the RF Power Supply and may result in internal damage or a fire.

Note: Install or remove the solenoid water valve in accordance with the water fitting installation or removal methods outlined above.

Step	Action
1.	Thread the pipe nipple on the “OUT” port of the solenoid valve into the “WATER IN” port on the rear panel.
2.	Connect the coolant water “supply” line to the “IN” port on the solenoid valve. Use a wrench on the hex nipple between the water valve and the “WATER IN” port to prevent over-tightening of the nipple into the “WATER IN” port.
3.	Connect the coolant water “return” line to the “WATER OUT” port on the rear panel.
4.	Plug the water valve’s connector into the rear panel “VALVE” connector.

RF Output Connection:

Connect the RF Power Supply’s RF output to a suitable load via a coaxial cable. Depending on the load configuration and application, several coaxial cable types may be used. Consult with the Seren IPS Inc. sales department, customer service department, or a Seren IPS Inc. representative to select the cable appropriate to your installation.

Coaxial cable types RG-213/U, RG-225/U or RG-393/U are typically used with RF Power Supply installations.



CAUTION: Do not enable mains power or operate the RF Power Supply without connecting a suitable load to the RF Output connector. Operating without a suitable load may damage the RF Power Supply and void the warranty.



WARNING: Do not enable mains power or operate the RF Power Supply without connecting a suitable load to the RF Output connector. Operating without a suitable load connected to the RF Output connector may create a Shock, Electrocution, or RF Energy Burn Hazard

Connection to AC Mains:

BEFORE connecting the RF Power Supply the AC mains, verify the AC Mains voltage marked on the ratings plate, located on the top or side panel of the RF Power Supply, is compatible with your AC Mains voltage. If the AC Mains voltage on the ratings plate is not compatible with your AC Mains voltage, contact a Seren IPS Inc. service depot for assistance.



CAUTION: CHECK YOUR MAINS VOLTAGE AND THE MAINS VOLTAGE SPECIFIED ON THE RATINGS PLATE OR CONSULT A QUALIFIED ELECTRICIAN BEFORE CONNECTING THE RF POWER SUPPLY TO MAINS POWER. CONNECTING THE RF POWER SUPPLY TO THE WRONG MAINS VOLTAGE MAY DAMAGE THE RF POWER SUPPLY AND VOID THE WARRANTY.

Models with detachable power cords:

Step	Action
1	Ensure a suitable load is connected to the rear panel RF OUTPUT connector
2	Ensure the front panel power switch is in the "OFF" (0) position
3	Ensure the rear panel circuit breaker is in the "OFF" (0) position
4	Plug the power cord into the power inlet on the rear panel of the RF power supply
5	Plug the power cord into the AC Mains power outlet

Models with captive power cords:

Step	Action
1	Ensure a suitable load is connected to the rear panel RF OUTPUT connector
2	Ensure the front panel power switch is in the "OFF" (0) position
3	Ensure the rear panel circuit breaker is in the "OFF" (0) position
4	Plug the power cord into the AC Mains power outlet

System Interfacing:

The RF Power Supply can be used “stand-alone” or can be interfaced with a processing system. There are connectors on the rear panel dedicated to system interfacing. Refer to the Rear Panel Controls and Connections section for detailed pin lists and signal descriptions. There are many possible interface schemes – a full discussion of interface schemes is beyond the scope of this document. Contact the Seren IPS Inc. customer service department if you require assistance with interface connections. A brief summary of the connectors is listed below.

“Analog Control” Connector

Provides status and control signals for an external system controller to operate the RF Power Supply. Because of different features available on different models, the Analog Control connector pin-list is slightly different on some models. Refer to the Rear Panel Controls and Connections section for interface details.



The analog interface's EXTERNAL INTERLOCK circuit *must* be completed or the RF Power Supply will not turn on. Refer to Rear Panel Controls and Connections for details.

“Serial Interface” Connector

Serial communications port for computer control via RS-232, RS-422, or RS-485 protocols.

“CEX IN” Connector

Radio Frequency signal input. The RF Power Supply uses the signal present at this connector as the frequency source when the RF Power Supply is configured for “slave” operation in a multiple RF power supply system. The CEX IN signal must be the same frequency (or frequency range) as the RF Power Supply's internal frequency source.

“CEX OUT” Connector

Radio Frequency signal output. The signal present at this connector is the same frequency the RF Power Supply is using to produce its RF output. This signal can be used as a frequency signal source for other RF Power supplies in a multiple RF power supply system.

“DCP” Connector (optional, 100 Watt and 300 Watt models only)

Voltage Probe Inverter input. This optional circuit inverts the output of a passive DC Voltage Probe when using external feedback for power regulation (voltage control). When installed, a 0 to –10VDC signal applied to this connector produces a 0 to +10VDC output that is routed to the Analog Interface connector's FEEDBACK signal. Refer to the Analog Interface Connector and Typical Interface Connections sections for details.

Front Panel Controls and Display:

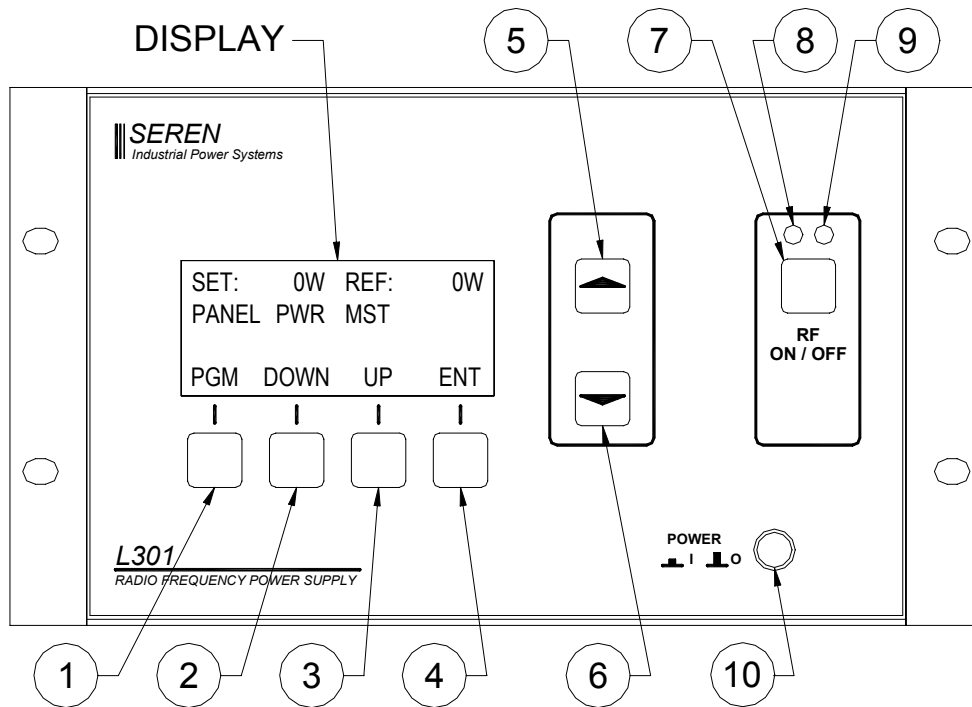

Buttons (Model L301 Shown, functions are the same for all R/LX01 series models)

Item	Name	Description
1	Program/Run	Toggles the RF Power Supply between the RUN mode and PROGRAM mode. In Program mode, display line 3 changes to show Programmable Menu Entry Options. The button legend changes from “PGM” to “RUN” when in the Program mode.
2	Down	Moves down the programming menu
3	Up	Moves up the programming menu
4	Enter	Programs (saves) changes made to a parameter
5	Value Up	Changes Parameter Value - Increment
6	Value Down	Changes Parameter Value - Decrement
7	RF ON/OFF	Enables/Disables the RF output in “local” mode, disables the RF output in any operational mode.
8	RF ON Indicator Lamp	Glows RED when the RF Output is enabled (on).
9	RF OFF Indicator Lamp	Glows BLUE when the RF output is disabled (off)
10	Power	AC Mains power enable/disable

Display

The front panel display shows the operational status of the RF Power Supply and provides legends for the keypad.

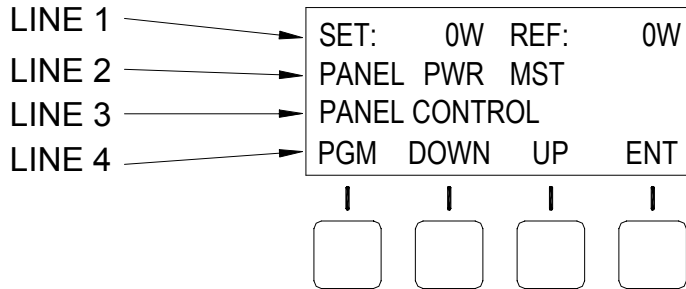

Line	Description
1	<p>Power Display Line</p> <p>Displays power setpoint and reflected power when the RF Output is disabled. Displays forward power (or load power) and reflected power when the RF output is enabled</p>
2	<p>Status Display Line</p> <p>Displays the current control source, power control mode, exciter mode and operational alarms. Operational alarms are displayed on the extreme right side of the line (see the problem solving section for alarm details).</p> <p>[CONTROL SOURCE] [POWER CONTROL MODE] [EXCITER MODE] [ALARM]</p> <p>Control Source: Panel = Front Panel Control Analog = Analog Interface Serial = Serial Interface</p> <p>Power Control Mode: PWR = Forward Power Leveling (internal power sensor) PLS = Pulsing Enabled (internal power sensor) VLT = Voltage Control (external feedback)</p> <p>Exciter Mode: MST = Master (internal frequency source) SLV = Slave (external frequency source)</p>
3	<p>User Configurable Display Line</p> <p>In RUN mode: Displays DC Voltage Probe or RF Voltage Probe output (User enabled or disabled)</p> <p>In PROGRAM mode: Displays a programmable parameter and its current setting.</p>
4	<p>Keypad Menu – button legends change depending on mode</p>

Operation

Front panel operation of the RF Power Supply is simple. This section describes the use and operation of the front panel controls in a “how to...” manner. Refer to the front panel illustration on the previous page for item references.



Connect the RF Power Supply's RF output to a 50-Ohm resistive load, Impedance Matching network, processing system or other suitable load capable of handling the unit's full rated power output *before* enabling AC mains Power.

Basic Front Panel Operation

Mains Power On/Off:

Press the POWER button (item 10) to enable mains power – the front panel display will illuminate and momentarily display the firmware revision and copyright. Press the POWER button again to disable mains power.

Control Source:

The control source is the control interface for the RF Power Supply. The RF Power Supply has three (3) user-selectable control sources.

- The “PANEL” control source is for front panel operation of the RF Power Supply.
- The “ANALOG” control source is for controlling the RF Power Supply from the user's system, via the rear panel ANALOG INTERFACE connector.
- The “SERIAL” control source is used for controlling the RF Power Supply from a computer or system controller, via an RS-232, RS-422, or RS-485 interface.

To select a control source, follow the directions below:

PANEL control:

To change the control source to the front panel,

1. Press the PGM button (Item 1) once (enter the programming menu).
2. Press the DOWN button (item 2) or the UP button (item 3) until line 3 of the display shows the current control source (PANEL CONTROL, ANALOG CONTROL, or SERIAL CONTROL).
3. Press the VALUE UP button (item 5) or the VALUE DOWN button (item 6) until PANEL CONTROL is displayed on line 3.
4. Press the ENT button (item 5) to save the selection.
5. Press the RUN button (item 1) to exit the programming menu.

ANALOG control:

To change the control source to the Analog interface connector,

1. Press the PGM button (Item 1) once.

2. Press the DOWN button (item 2) or the UP button (item 3) until line 3 of the display shows the current control source (PANEL CONTROL, ANALOG CONTROL, or SERIAL CONTROL).
3. Press the VALUE UP button (item 5) or the VALUE DOWN button (item 6) until ANALOG CONTROL is displayed on line 3.
4. Press the ENT button (item 5) to save the selection.
5. Press the RUN button (item 1) to exit the programming menu.

SERIAL control:

To change the control source to the Serial interface connector,

1. Press the PGM button (Item 1) once.
2. Press the DOWN button (item 2) or the UP button (item 3) until line 3 of the display shows the current control source (PANEL CONTROL, ANALOG CONTROL, or SERIAL CONTROL).
3. Press the VALUE UP button (item 5) or the VALUE DOWN button (item 6) until SERIAL CONTROL is displayed on line 3.
4. Press the ENT button (item 5) to save the selection.
5. Press the RUN button (item 1) to exit the programming menu.

Note: Pressing the RUN button (item 1) exits the programming menu. If changes were made and the ENT button *was not* pressed, the changes will not be preserved after a power-off/power-on cycle.

Note: The control source and control mode selections are saved when the ENT button is pressed. The RF Power Supply will power-up in the same mode.

Leveling Mode:

The leveling mode is the method the RF Power Supply uses to regulate its output power. There are three (3) leveling mode selections.

- The “PWR” (power) leveling mode uses the unit’s internal power sensor to regulate the RF output power. There are two types of internal power leveling available on the RF Power Supply:
 1. Forward (FWD) Power leveling: The forward output power is measured by the RF Power Supply’s internal power sensor and compared against the requested output power (power setpoint). The unit’s power amplifier increases or decreases its output to maintain the requested power setpoint. Reflected power is displayed and monitored for internal protection.
 2. Load Power Leveling: The forward and reflected power is measured by the RF Power Supply’s internal power sensor. The reflected power signal is subtracted from the forward power signal and compared against the requested net power (power setpoint) to be delivered to the load. The unit’s power amplifier output

increases or decreases its output to maintain the net power delivered to the load. Reflected power is displayed and monitored for internal protection.

- The “VOLTAGE” (VLT) leveling mode uses an external feedback voltage (derived from a Voltage Probe in the processing system’s matching network or processing chamber) to regulate the RF output power.

To select a leveling mode, follow the directions below:

Forward (FWD) Power Leveling mode:

1. Press the “PGM” button (item 1).
2. Press the “DOWN” button (item 2) until line three of the display is “POWER CONTROL” or “VOLTAGE CONTROL”
3. Press the “VALUE UP” button (item 5) or “VALUE DOWN” (item 6) until line 3 of the display indicates the desired power leveling mode, “POWER CONTROL”.
The text on the left side of display line 2 should change to “PANEL PWR”
4. Press the “ENT” button (item 4) to save the mode selection.
5. Press the “DOWN” button (item 2) until line three reads “FWD POWER LEVELING” or “LOAD POWER LEVELING”
6. Press the “VALUE UP” button (item 5) or “VALUE DOWN” (item 6) until line 3 of the display indicates the desired power leveling mode, “FWD POWER LEVELING”.
7. Press the “ENT” button (item 4) to save the mode selection.
5. Press the “RUN” button (item 1) to exit the programming menu.

Voltage (VLT) Leveling mode:

1. Press the “PGM” button (item 1).
2. Press the “DOWN” button (item 2) until line 3 of the display is “POWER CONTROL” or “VOLTAGE CONTROL”
3. Press the “VALUE UP” button (item 5) or “VALUE DOWN” (item 6) until line 3 of the display indicates the desired power leveling mode, “VOLTAGE CONTROL”.
The text on the left side of display line 2 should change to “PANEL VLT”
4. Press the “ENT” button (item 4) to save the mode selection.
5. Press the “RUN” button (item 1) to exit the programming menu.

Load (LOAD) Power Leveling mode:

1. Press the “PGM” button (item 1).
2. Press the “DOWN” button (item 2) until line three of the display is “POWER CONTROL” or “VOLTAGE CONTROL”
3. Press the “VALUE UP” button (item 5) or “VALUE DOWN” (item 6) until line 3 of the display indicates the desired power leveling mode, “POWER CONTROL”.
The text on the left side of display line 2 should change to “PANEL PWR”
4. Press the “ENT” button (item 4) to save the mode selection.

5. Press the “DOWN” button (item 2) until line three reads “FWD POWER LEVELING” or “LOAD POWER LEVELING”
6. Press the “VALUE UP” button (item 5) or “VALUE DOWN” (item 6) until line 3 of the display indicates the desired power leveling mode, “LOAD POWER LEVELING”.
7. Press the “ENT” button (item 4) to save the mode selection.
8. Press the “RUN” button (item 1) to exit the programming menu.

Set Output Power Level

1. Ensure the RF Power Supply is in the “RUN” mode – the legend above the Program/Run button (item 1) is “PGM”.
2. Use the Value Up button (item 5) or Value Down button (item 6) to adjust the power setpoint (SET: XXXW on the front panel display) to the desired power level.

Enable RF Output

1. Ensure the RF Power Supply's RF output is connected to an appropriate load and the external interlock (Analog Interface Connector, pin 2) is in the proper state.
2. Press the front panel RF ON/OFF button (item 7). The blue RF OFF lamp will extinguish (item 9) and the red RF ON lamp will illuminate.
3. The left side of line one on the display will change from “SET XXXW” to “FWD XXXW”

Disable RF Output

1. Press the front panel RF ON/OFF button (item 7). The red RF ON lamp should extinguish (item 9) and the blue RF OFF lamp will illuminate.
2. The left side of line one on the display will change from “FWD XXXW” to “SET XXXW”

Basic Analog Interface Operation

Refer to the Rear Panel Controls and Connections and the Typical Interface Connections sections for detailed analog interface operation and connection information.



Connect the RF Power Supply's RF output to a 50-Ohm resistive load, Impedance Matching network, processing system or other suitable load capable of handling the unit's full rated power output *before* enabling AC mains Power.

1. Make control connections to the rear panel ANALOG INTERFACE connector.
2. Press the front panel POWER button (item 10) to enable mains power – the front panel display will illuminate and momentarily display the firmware revision and copyright.
3. Select ANALOG control mode.

Note: The ANALOG control mode only needs to be selected once. The RF Power Supply will retain the selected control mode during a power-off/power-on cycle.

- a. Press the PGM button (Item 1) once.
 - b. Press the DOWN button (item 2) or the UP button (item 3) until line 3 of the display shows the current control source (PANEL CONTROL, ANALOG CONTROL, or SERIAL CONTROL).
 - c. Press the VALUE UP button (item 5) or the VALUE DOWN button (item 6) until ANALOG CONTROL is displayed on line 3.
 - d. Press the ENT button (item 5) to save the selection.
 - e. Press the RUN button (item 1) to exit the programming menu.
4. Select the desired leveling mode “Power” or “Voltage”.

Apply an open circuit or TTL “high” signal to Analog Interface Connector pin 4 to select the power supply's internal power sensor for power regulation. A contact closure between Analog Interface Connector pin 4 and pin 16 or a TTL “low” signal applied to pin 4 selects forward power regulation based on an external feedback signal (FEEDBACK signal – Analog Interface Connector pin 12).

5. Apply the desired setpoint voltage to the SETPOINT signal (Analog Interface Connector pin 13) and SETRET signal (Analog Interface Connector pin 25).
6. Enable the Analog Interface Connector's external interlock (INTERLOCK) circuit. Connect Analog Interface connector pin 2 to pin 15 or apply a TTL logic “low” signal to pin 2.
7. Enable the Analog Interface Connector's RF On (RFON*) circuit. Connect Analog Interface Connector pin 3 to pin 16 or apply a TTL logic “low” signal to pin 3.



Note: the RFON* signal is edge triggered. A transition from a TTL “high” to TTL “low” logic state must occur to enable the RF output. This prevents accidental enabling of the RF output when the RF power supply is powered-up in the ANALOG control mode or when the external interlock (INTERLOCK) is re-established after an external system interlock event.

8. Adjust the setpoint voltage as required.
9. Disable the RF Output. Open the connection between Analog Interface Connector pin 3 to pin 16 or apply a TTL logic “High” signal to pin 2.

Basic Serial Interface Operation

Refer to the [Rear Panel Controls and Connections](#) section for serial interface connection details. Serial commands are detailed in the [Serial Commands](#) Section.

The serial interface communications protocol is selectable; RS-232, RS-485 4-wire, or RS-485 2-wire, MODBUS 2-Wire, MODBUS 4-Wire with 8 data bits, 1 stop bit, no parity. The baud rate is selectable, 2400, 4800, 9600, 19200, 38400, 57600, or 115200 Baud (see below). The factory default baud rate is 19,200 baud. The factory default serial address is 99 (RS422/485/MODBUS protocols).



Connect the unit's RF output to a 50-Ohm resistive load, Impedance Matching network, processing system or other suitable load capable of handling the unit's full rated power output before enabling AC mains Power.

1. Connect a terminal, personal computer, or system controller to the rear panel SERIAL interface connector. NOTE: the Serial Interface connector uses a non-standard pin-list. Refer to the [Rear Panel Controls and Connections](#) section for connection details.
2. Press the front panel POWER button (item 10) to enable mains power – the front panel display will illuminate and momentarily display the firmware revision and copyright.
3. Select SERIAL control mode.

Note: The SERIAL control mode only needs to be selected once. The RF power supply will retain the selected control mode during a power-off/power-on cycle.

- a. Press the PGM button (Item 1) once.
 - b. Press the DOWN button (item 2) or the UP button (item 3) until line 3 of the display shows the current control source (PANEL CONTROL, ANALOG CONTROL, or SERIAL CONTROL).
 - c. Press the VALUE UP button (item 5) or the VALUE DOWN button (item 6) until SERIAL CONTROL is displayed on line 3.
 - d. Press the ENT button (item 5) to save the selection.
 - e. Remain in the programming environment, ***do not*** press the RUN button.
4. Select the SERIAL COMMUNICATIONS PROTOCOL:
Serial control must be selected before attempting to select the communications protocol. If the unit is set for PANEL or ANALOG control mode, the communications protocol selection will not appear in the programming menu.

Note: The serial communications protocol only needs to be selected once. The RF power supply will retain the selected serial communications protocol during a power-off/power-on cycle.

Note: If you are changing the serial communications protocol from RS-422 or RS-485 or MODBUS to RS-232, ensure the unit's serial address is set to "99" before selecting the RS-232 protocol. See the next item (item 5 - below) for address selection details.

- a. Press the DOWN button (item 2) or the UP button (item 3) until line 3 of the display shows the current serial communications protocol - RS232, RS422, RS485-4 (4 wire), RS485-2 (2 wire), MODBUS 2W (2 wire) or MODBUS 4W (4 wire).
- b. Press the VALUE UP button (item 5) or the VALUE DOWN button (item 6) until the desired serial protocol is displayed on line 3
- c. Press the ENT button (item 5) to save the selection.

5. Set the unit's SERIAL ADDRESS (required for RS-422, RS-485 and MODBUS protocols):

Serial Control *and* RS422 or RS485 protocol must be selected before attempting to set the unit's address. If the unit is set for PANEL or ANALOG control mode, or RS-232 communications protocol, the address selection will not appear in the programming menu.

Note: The serial address only needs to be set once. The RF power supply will retain the selected address during a power-off/power-on cycle.

For single user (single drop) RS232, RS422, RS485, or MODBUS communications, set the unit's address to "99" (factory default). Since RS-232 only supports single-drop, the unit's address must be set to "99" *before* selecting RS232 as the communications protocol.

- a. Press the DOWN button (item 2) or the UP button (item 3) until line 3 of the display shows the address (RS485/422 # XX).
- b. Press the VALUE UP button (item 5) or the VALUE DOWN button (item 6) until the desired address (0-99) is displayed on line 3
- c. Press the ENT button (item 5) to save the selection.

6. Select the BAUD rate:

Serial control must be selected before attempting to select the baud rate. If the unit is set for PANEL or ANALOG control mode, the baud rate selection will not appear in the programming menu.

Note: The BAUD rate only needs to be selected once. The RF power supply will retain the selected BAUD rate during a power-off/power-on cycle.

- a. Press the DOWN button (item 2) or the UP button (item 3) until line 3 of the display shows the current baud rate.
- b. Press the VALUE UP button (item 5) or the VALUE DOWN button (item 6) until the desired baud rate is displayed on line 3
- c. Press the ENT button (item 5) to save the selection.
- d. Press the RUN button (item 5) to exit the programming menu.

7. Send the desired serial command to the RF Power Supply.

Serial Commands

The underscore character (_) indicates a space, terminators are specified as carriage return–line feed <crlf> or carriage return <cr>.

Unless otherwise specified, with ECHO mode set to *disabled*, the RF Power Supply responds with <cr>” for an accepted command, or “N<cr>” for an invalid command.

Unless otherwise specified, with ECHO mode set to *enabled*, the RF Power Supply responds with “<command string><cr>” and a command response (where applicable) for an accepted command, or “N<cr>” for an invalid command.

RS-485 (2-wire) communications protocol does not support ECHO mode (set to *disabled* by software default).

RS-422 communications protocol mode is listen-only.

The prompt character is <cr>

Note: All serial commands shown. Some serial commands are not applicable to all models. Refer to the Serial Command Details section for application information.

SERIAL COMMAND REFERENCE CHART

- NOTES: The underscore character (_) indicates a space
 Prompt character is the carriage return (<cr>) symbol
 The letter “X” indicates a variable character.
 Response to all invalid commands: “N<cr>”
 Responses shown in the chart below assume ECHO mode is *disabled*.

SERIAL COMMAND REFERENCE			
TO	SEND	DESCRIPTION/COMMENT	Applies To
Assert SERIAL control	***<cr> or SERIAL<cr>	Sets the serial interface as the control source. Response: <cr>	All
Enable serial command ECHO mode	ECHO<cr>	Response to commands includes the <prompt> plus the command string sent to the unit, terminated with <cr>. Response: <cr>	All
Disable serial command ECHO mode	NOECHO<cr>	Suppresses the echo of commands. Response for accepted (acknowledged) commands is <prompt><cr>. Response for invalid commands is N<cr> Response: <cr>	All
Assert ANALOG control	ANALOG<cr>	Sets the analog interface as the control source. Response: <cr>	All

SERIAL COMMAND REFERENCE			
TO	SEND	DESCRIPTION/COMMENT	Applies To
Assert PANEL control	PANEL<cr>	Sets the front panel as the control source. Response: <cr>	All
Set the Operating Frequency	XXX_FQ<cr>	XXX is the operating frequency in KHz, 3 digits, 100-460KHz, 1 KHz increments Response: <cr>	L-Series Models
	XXX_FQ<cr>	XXX is the desired operating frequency, 1.70 to 2.10MHz in 10 KHz increments (decimal is omitted) Response: <cr>	1.7-2.1MHz R-Series Models
Set the Exciter Mode to MASTER	MST<cr>	Selects the RF Power Supply's internal frequency source. Response: <cr>	All
Set the Exciter Mode to SLAVE	SLV<cr>	Selects the rear panel CEX IN connector as the frequency source. Response: <cr>	All
Select FORWARD POWER leveling	DL<cr>	Regulates the RF output level based solely on the forward power feedback signal. Response: <cr>	All
Select LOAD POWER leveling	EL<cr>	Regulates the RF output power based on the net power delivered to the load. (forward power – reflected power = net power) Response: <cr>	All
Select POWER CONTROL mode	IR<cr>	Sets the unit's internal power sensor as the feedback source for regulating the RF output level. Response: <cr>	All
Select VOLTAGE CONTROL mode	DR<cr>	Sets the Analog Interface connector FEEDBACK signal as the feedback source for regulating the RF output level. Response: <cr>	All
Set the Power Setpoint	XXXX_W<cr>	XXXX is the desired power output, in Watts. 1 to 4 digits. Response: <cr>	All
Set the Power Setpoint to 0 Watts <i>and disable</i> RF output	WS<cr>	Sets power setpoint to Zero (0) Watts and Disable the RF output Response: <cr>	All
Set the Power Setpoint <i>and enable</i> RF Output	XXXX_WG<cr>	XXXX is the desired power output, in Watts. 1 to 4 digits. Response: <prompt><cr>	All
Set the Voltage Setpoint	XXXX_V<cr>	XXXX is the desired output, in Volts. 1 to 4 digits.	All

SERIAL COMMAND REFERENCE			
TO	SEND	DESCRIPTION/COMMENT	Applies To
		Response: <cr>	
Set the Process Pulse duty cycle	XXX_D<cr>	XXX is the process pulse duty cycle, 1 to 100%, in 1 % increments. 1 to 3 digits. Response: <cr>	All models except R/L301
Set the Process Pulse Frequency	XXXX_PR<cr>	XXXX is the process pulse frequency, in Hertz, 1Hz to 1000Hz, in 1Hz increments	Custom OEM Config
Set the Process Pulse high time	XXXX_HT<cr>	XXXX is the process pulse high time, in milliseconds. 1mS to 9999mS. Response: <cr>	All models except R/L301
Set the Process Pulse High Power Setpoint	XXXX_HP<cr>	XXXX is the process pulse high power setpoint, in Watts. 1 to 4 digits. Response: <cr>	All models except R/L301
Set the Process Pulse Low Power Setpoint	XXXX_LP<cr>	XXXX is the process pulse low power setpoint, in Watts. 1 to 4 digits. Response: <cr>	R301MKII, L301MKII Models only
Enable PULSE mode	+P<cr>	Enables Process Pulsing Response: <cr>	All models except R/L301
Disable PULSE mode	-P<cr>	Disables Process Pulsing Response: <cr>	All models except R/L301
Set VFT Coarse Trip Ratio	XXX_CR<cr>	XXX is the (Reflected Power) / (Forward Power) ratio Range 1 to 100, 1 to 3 digits Response: <cr>	1.7-2.1MHz R-Series Models L-Series Models
Set VFT Coarse Frequency Step	XXXXX_CF<cr>	XXXXX is the coarse frequency step, 1 Hz to 10,000 Hz, 1 Hz increments, 1 to 5 digits Response: <cr>	1.7-2.1MHz R-Series Models L-Series Models
Set VFT Fine Frequency Step	XXXXX_FF<cr>	XXXXX is the fine frequency step, 1 Hz to 10,000 Hz, 1 Hz increments, 1 to 5 digits Response: <cr>	1.7-2.1MHz R-Series Models L-Series Models
Set VFT Fine Trip Level	XXX_FT<cr>	XXX is the reflected power level, in Watts, 1 to 3 digits, where VFT stops attempt to match the load Response: <prompt><cr>	1.7-2.1MHz R-Series Models L-Series Models
Set Maximum VFT	XXX_MAXVF<cr>	XXX is the maximum frequency the VFT	1.7-2.1MHz

SERIAL COMMAND REFERENCE			
TO	SEND	DESCRIPTION/COMMENT	Applies To
Frequency		feature may use. R-Series Models: 10 KHz increments L-Series Models: 1 KHz increments. Response: <cr>	R-Series Models L-Series Models
Set Minimum VFT frequency	XXX_MINVF<cr>	XXX is the minimum frequency the VFT feature may use. R-Series Models: 10 KHz increments L-Series Models: 1 KHz increments. Response: <cr>	1.7-2.1MHz R-Series Models L-Series Models
Set VFT Strike Frequency	XXX_SF<cr>	XXX is the desired strike frequency. R-Series Models: 10 KHz increments L-Series Models: 1 KHz increments. Response: <cr>	1.7-2.1MHz R-Series Models L-Series Models
Enable Variable Frequency Tuning (VFT)	VX<cr>	Enables VFT feature. Response: <cr>	1.7-2.1MHz R-Series Models L-Series Models
Disable Variable Frequency Tuning (VFT)	FX<cr>	Disables VFT feature. Response: <cr>	1.7-2.1MHz R-Series Models L-Series Models
Enable RF Output	G<cr>	Enable the RF Output Response: <cr>	All
Disable RF Output	S<cr>	Disable the RF Output Response: <cr>	All
Enable RF Output Ramping	EU<cr>	Enables RF output Ramp-Up and Ramp-Down Response: <cr>	All
Disable RF Output Ramping	DU<cr>	Disables RF output Ramp-Up and Ramp-Down Response: <cr>	All
Set RF output Ramp-Down time interval	XXXX_DN<cr>	XXXX is the desired ramp down time interval, 1 to 9999 seconds, in 1-second increments. 1 to 4 digits.	All
Set RF output Ramp-Up time interval	XXXX_UP<cr>	XXXX is the desired ramp up time interval, 1 to 9999 seconds, in 1-second increments. 1 to 4 digits.	All
Query the Forward Power output	W?	Returns forward power output, in Watts, 1 to 4 digits, 1-Watt increments	All

SERIAL COMMAND REFERENCE			
TO	SEND	DESCRIPTION/COMMENT	Applies To
		Response: XXXX<cr>	
Query Reflected Power	R?	Returns reflected power, in Watts, 1 to 4 digits, 1-Watt increments Response: XXXX<cr>	All
Query the DC Bias Voltage	0?<cr>	Returns the developed DC Bias Voltage, with scaling and probe attenuation factors applied. Response: XXXX<cr> (Negative polarity is assumed) Note: R/LX01 series RF Power supplies have only one external feedback channel, therefore, this command is identical to the "V?" command.	All
Query the Control Voltage	V?<cr>	Returns the Control Voltage, with scaling and probe attenuation factors applied. Response: XXXX<cr> (Negative polarity is assumed) Note: R/LX01 series RF Power supplies have only one external feedback channel, therefore, this command is identical to the "0?" command.	All
Query Power Leveling Mode	LVL?<cr>	Returns the current power leveling mode: Response: 0<cr> for Forward Power Leveling 1<cr> for Load (net) Power Leveling.	All
Query Status (Long Form)	Q<cr>	Returns status in the form of a mapped string, terminated with <cr>. See Serial Command details for string mapping information.	All
Query Status (Short Form)	R<cr>	Returns status in the form of a mapped string, terminated with <cr>. See Serial Command details for string mapping information.	All
Query Maximum Power	M?<cr>	Returns the absolute maximum forward power of the unit. Response: XXXX<cr> XXXX is maximum forward power, in Watts, 1 to 4 digits, 1-Watt increments	All
Query MC2 Load Capacitor Preset Position	LPS<cr>	Returns the current Load Capacitor Preset position stored in the MC2's memory. Response: XXX<cr> XXX is the Load Capacitor preset position, 0 to 100, in percent, 1 to 3 digits, in 1% increments	All

SERIAL COMMAND REFERENCE			
TO	SEND	DESCRIPTION/COMMENT	Applies To
Query MC2 Tune Capacitor Preset Position	TPS<cr>	Returns the current Tune Capacitor Preset position stored in the MC2's memory Response: XXX<cr> XXX is the Tune Capacitor preset position, 0 to 100, in percent, 1 to 3 digits, in 1% increments	All
Set MC2 Load Capacitor Preset Position	XXX_MPL<cr>	XXX is the desired Load Capacitor preset position, 0 to 100, in percent, 1 to 3 digits, in 1% increments Response: <cr>	All
Set MC2 Tune Capacitor Preset Position	XXX_MPT<cr>	XXX is the desired Tune Capacitor preset position, 0 to 100, in percent, 1 to 3 digits, in 1% increments Response: <cr>	All
Query MC2 Phase Voltage	PHS<cr>	Returns the current Phase Error Voltage from MC2 Matching network controller. Response: XXXX<cr> XXXX is the Phase Error Voltage, in milli-Volts (mV), 1 to 4 digits.	All
Query MC2 Magnitude Voltage	MAG<cr>	Returns the current Magnitude Error Voltage from MC2 Matching network controller. Response: XXXX<cr> XXXX is the Magnitude Error Voltage, in milli-Volts (mV), 1 to 4 digits.	All

Serial Command Details

The underscore character (_) indicates a space, terminators are specified as carriage return–line feed <crlf> or carriage return <cr>.

Unless otherwise specified, with ECHO mode set to *disabled*, the RF Power Supply responds with <cr>” for an accepted command, or “N<cr>” for an invalid command.

Unless otherwise specified, with ECHO mode set to *enabled*, the RF Power Supply responds with “<command string><cr>” and a command response (where applicable) for an accepted command, or “N<cr>” for an invalid command.

RS-485 (2-wire) communications protocol does not support ECHO mode (set to *disabled* by software default).

RS-422 communications protocol mode is listen-only.

The prompt character is <cr>

Note: All serial commands shown. Some serial commands are not applicable to all models and are notated in the individual command detail descriptions.

- NOTES: The underscore character (_) indicates a space
 Prompt character is the carriage return (<cr>) symbol
 The letter “X” indicates a variable character.
 Response to all invalid commands: “N<cr>”
 Responses shown in the chart below assume ECHO mode is *disabled*

SERIAL COMMAND DETAILS		
COMMAND	COMMAND DETAIL	APPLIES TO
***	Assert SERIAL control mode. Switches control of the unit to the serial interface. Front panel setpoint and RF ON commands are ignored. Analog Interface Connector signals RFON* and SETPOINT are ignored. Note: The RF Power Supply powers-up in the last known control state. Note: This command is the same as the SERIAL command Command: ***<cr> Response: <cr>	All
0?	Query the DC Bias Voltage Responds with the external feedback (or DC Bias) Voltage, with Probe Attenuation and scaling factors applied. R/LX01 series RF Power supplies have only one external feedback channel, therefore, this command is identical to the “V?” command. A negative (-) polarity signal is assumed. Command: 0? Response: XXXX<cr>	All
ANALOG	Assert ANALOG control Switches control of the unit to the Analog Interface Connector. All serial	All

SERIAL COMMAND DETAILS		
COMMAND	COMMAND DETAIL	APPLIES TO
	<p>commands except "SERIAL<cr>" or "***<cr>" are ignored. Front panel power settings and RF ON commands are ignored.</p> <p>Note: The RF Power Supply powers-up in the last known control state.</p> <p>Command: ANALOG<cr></p> <p>Response: <cr></p>	
CR	<p>Set Variable Frequency Tuning Coarse Trip Ratio</p> <p>Command: XXX_CR<cr></p> <p>Where XXX is the reflected power of the reflected power to forward power ratio (XXX:1). The Coarse Ratio is a trigger used to switch between the coarse frequency stepping and the fine frequency stepping of the Variable Frequency Tuning (VFT) feature. Coarse frequency stepping is active when the reflected power to forward power ratio is greater than the VFT Coarse Ratio setting. Fine frequency stepping is active when the reflected power to forward power ratio is equal to or less than the VFT Coarse Ratio setting. Range: 1:1 to 100:1.</p> <p>Factory Default is 10:1</p> <p>Response: <cr></p>	<p>1.7-2.1MHz R-Series Models L-Series Models</p>
CF	<p>Set Variable Frequency Tuning Coarse Frequency Step</p> <p>Command: XXXXX_CF<cr></p> <p>Where XXXXX is the coarse frequency step, in Hz, 1 to 5 digits, 1 Hz to 10,000 Hz used by the Variable Frequency Tuning feature to match the load.</p> <p>Factory Default is 3000 Hz.</p> <p>Response: <cr></p>	<p>1.7-2.1MHz R-Series Models L-Series Models</p>
CGP?	<p>Query Process Pulse Parameters</p> <p>Command: CGP?<cr></p> <p>Response: aaa_bbb_ccc_dd<cr></p> <p>Where:</p> <p>“aaa” is the Start Power Parameter</p> <p>“bbb” is the Idle Power Parameter</p> <p>“ccc” is the PBN Start Current Parameter</p> <p>“dd” is the Power/Beam Factor Parameter</p> <p>Note: Process Pulse Parameters are stored in the RF Power Supply's memory and can be viewed or edited via the Programming Menu.</p>	<p>Custom OEM Configurations</p>
CSP?	<p>Query Process Start Parameters</p> <p>Command: CSP?<cr></p> <p>Response: aaa_bbb_ccc_ddd_eeee<cr></p> <p>Where:</p> <p>“aaa” is the Start Sense Voltage (Start Sense V)Parameter</p> <p>“bbb” is not implemented and always returns a “0”</p> <p>“ccc” is not implemented and always returns a “0”</p> <p>“ddd” is the Start Detect Current (Start Detect I) Parameter</p>	<p>Custom OEM Configurations</p>

SERIAL COMMAND DETAILS		
COMMAND	COMMAND DETAIL	APPLIES TO
	<p>“eeee” is the Start Pulse Voltage (Start Pulse V) Parameter</p> <p>Note: Process Pulse Parameters are stored in the RF Power Supply’s memory and can be viewed or edited via the Programming Menu.</p>	
D	<p>Set the Process Pulse Duty Cycle</p> <p>Command: XXX_D<cr></p> <p>Where XXX is the process pulse duty cycle, 1% to 100%, in 1% increments. 1 to 3 digits.</p> <p>Response: <cr></p>	All models except R/L301, R101
DL	<p>Select FORWARD POWER leveling</p> <p>Configures the RF Power Supply to deliver a constant Forward Power the load. The power setpoint is set by the front panel controls or the “W” serial command.</p> <p>Command: DL<cr></p> <p>Response: <cr></p>	All
DN	<p>Set RF Output Ramp-Down time</p> <p>Specifies the Ramp-Down time interval. When the RF output is disabled (by the front panel, analog interface or the “S” serial command), the RF output power is decreased from the current setpoint to 0 Watts over the specified time interval.</p> <p>Factory default value is 1.</p> <p>Related Commands: UP, DU, EU</p> <p>Note: RF output ramping is not available in Pulse mode or Voltage Control (external feedback) mode.</p> <p>RF output ramping is also configurable via the front panel programming menu.</p> <p>Command: XXXX_DN<cr></p> <p>Where XXXX is the Ramp Down time interval in seconds. Range: 1 to 9999 seconds, in 1-second increments, 1 to 4 digits.</p> <p>Response: <cr></p>	All
DR	<p>Select VOLTAGE CONTROL mode</p> <p>Selects the Analog Interface connector’s FEEDBACK signal as the feedback source for regulating the RF output level. Related commands: “V?”, “0?”, and “V”.</p> <p>Command: DR<cr></p> <p>Response: <cr></p>	All
DU	<p>Disable RF Output Ramping</p> <p>Disables RF output Ramp Up <i>and</i> RF output Ramp Down. The “DU” command does not modify the Ramp Up or Ramp Down time interval.</p> <p>Related Commands: DN, UP, EU</p> <p>Note: RF output ramping is not available in Pulse mode or Voltage Control (external feedback) mode</p> <p>RF output ramping is also configurable via the front panel programming menu.</p>	All

SERIAL COMMAND DETAILS		
COMMAND	COMMAND DETAIL	APPLIES TO
	<p>Command: DU<cr></p> <p>Response: <cr></p>	
ECHO	<p>Enable ECHO mode</p> <p>Response to serial commands includes the <prompt> plus the command string sent to the unit, terminated with <cr>.</p> <p>Command: ECHO<cr></p> <p>Response: <cr></p>	All
EL	<p>Select LOAD POWER leveling</p> <p>Configures the RF Power Supply to deliver a constant Net Power to the load. Net Power = (Forward Power – Reflected Power). The power setpoint is set by the front panel controls or the “W” serial command.</p> <p>Command: EL<cr></p> <p>Response: <cr></p>	All
EU	<p>Enable RF Output Ramping</p> <p>Enables RF output Ramp Up <i>and</i> RF output Ramp Down. The “EU” command does not modify the Ramp Up or Ramp Down time interval.</p> <p>Related Commands: DN, DU, UP</p> <p>Note: RF output ramping is not available in Pulse mode or Voltage Control (external feedback) mode.</p> <p>RF output ramping is also configurable via the front panel programming menu.</p> <p>Command: EU<cr></p> <p>Response: <cr></p>	All
FF	<p>Set Variable Frequency Tuning Fine Frequency Step</p> <p>Command: XXXXX_FF<cr></p> <p style="padding-left: 20px;">Where XXXXX is the fine frequency steps, in Hz, 1 to 5 digits, 1 Hz to 10,000 Hz, used by the Variable Frequency Tuning feature to match the load (minimize reflected power).</p> <p style="padding-left: 20px;">Factory Default is 1000 Hz.</p> <p>Response: <cr></p>	1.7-2.1MHz R-Series Models L-Series Models
FT	<p>Set Variable Frequency Tuning Fine Trip Level</p> <p>Command: XXX_FT<cr></p> <p style="padding-left: 20px;">Where XXX is the reflected power level, in Watts, 1 to 3 digits, where Variable Frequency Tuning stops attempting to match to the load by adjusting the RF output frequency. Factory default is 2 Watts.</p> <p>Response: <cr></p>	1.7-2.1MHz R-Series Models L-Series Models
FQ	<p>Set the Operating Frequency</p> <p>Command: XXX_FQ<cr></p> <p style="padding-left: 20px;">L-Series: XXX is the desired operating frequency, 100 KHz to 460 KHz, in 1 KHz increments.</p> <p style="padding-left: 20px;">1.7-2.1MHz R-Series: XXX is the desired operating frequency, 1.70 to 2.10MHz in 10 KHz increments (decimal is omitted)</p>	1.7-2.1MHz R-Series Models L-Series Models

SERIAL COMMAND DETAILS		
COMMAND	COMMAND DETAIL	APPLIES TO
	Response: <cr>	
FX	<p>Set Variable Frequency Tuning Feature to Disabled</p> <p>Command: FX<cr></p> <p>Response: <cr></p>	<p>1.7-2.1MHz R-Series Models L-Series Models</p>
G	<p>Enable the RF Output</p> <p>Command: G<cr></p> <p>Response: <cr></p>	All
HP	<p>Set the Process Pulse High Power Setpoint</p> <p>Command: XXXX_HP<cr></p> <p>Where XXXX is the process pulse high power setpoint, in Watts. 1 to 4 digits, 0 Watts to Rated Power (Watts).</p> <p>Response: <cr></p>	<p>All models except R/L301, R101</p>
HT	<p>Set the Process Pulse High Time</p> <p>Command: XXXX_HT<cr></p> <p>Where XXXX is the process pulse high time, in milliseconds. 1 to 4 digits, 1mS to 9999mS.</p> <p>Response: <cr></p>	<p>All models except R/L301, R101</p>
IR	<p>Select POWER CONTROL mode</p> <p>Selects the RF Power Supply's internal power sensor as the feedback source for regulating the RF output level. Used in conjunction with the "DL", "EL", and "W" commands.</p> <p>Command: IR<cr></p> <p>Response: <cr></p>	All
LP	<p>Set the Process Pulse Low Power Setpoint</p> <p>Command: XXXX_LP<cr></p> <p>Where XXXX is the process pulse low power setpoint, in Watts. 1 to 4 digits, 0 Watts to Rated Power (in Watts)</p> <p>Response: <cr></p>	<p>R301MKII, L301MKII Models only</p>
LPS	<p>Query the MC2 Controller's Load Capacitor Preset position.</p> <p>The "LPS" command is passed through the RF Power Supply to the Seren IPS Inc. model MC2 Matching Network Controller. The MC2's response is passed back through the RF Power Supply to the user's equipment. The RF Power Supply does not use or store the information.</p> <p>Note: Sending the LPS command to the Seren IPS Inc. Model MC2 matching network controller from the RF Power Supply requires a serial interface connection from the RF Power Supply to the MC2 matching network controller's serial interface connector.</p> <p>Command: LPS<cr></p> <p>Response: XXX<cr></p> <p>Where XXX is the Load Capacitor Preset position stored in the MC2 Matching Network Controller's memory. 0 to 100, in percent. 1 to 3</p>	All

SERIAL COMMAND DETAILS		
COMMAND	COMMAND DETAIL	APPLIES TO
	digits.	
LVL?	<p>Query Power Leveling Mode</p> <p>Returns the current power leveling mode:</p> <p>Command: LVL?<cr></p> <p>Response:</p> <p style="padding-left: 20px;">0<cr> for Forward Power Leveling</p> <p style="padding-left: 20px;">1<cr> for Load (net) Power Leveling</p>	All
M?	<p>Query Absolute Maximum Forward Power</p> <p>Command: M?<cr></p> <p>Response: XXXX<cr></p> <p style="padding-left: 20px;">Where XXXX is the Maximum Forward Power of the RF Power Supply, in 1-Watt increments, length: 4 characters, fixed. Leading zeros are replaced with the blank space character.</p> <p style="padding-left: 20px;">Example: A 600 watt unit would return “_600<cr>”</p> <p style="padding-left: 20px;">This parameter <i>is not</i> configurable.</p>	All
MAG	<p>Query the MC2 Controller's Magnitude Error Voltage</p> <p>The “MAG” command is passed thorough the RF Power Supply to the Seren IPS Inc. model MC2 Matching Network Controller. The RF Power Supply does not use or store the information.</p> <p>Note: Querying of the of MC2 Matching Network Controller's Magnitude Error Voltage from the RF Power Supply requires a serial interface connection from the RF Power Supply to the MC2 matching network controller. The magnitude error voltage is normally associated with the operation of the matching network's “Load” or “shunt” capacitor.</p> <p>Command: MAG<cr></p> <p>Response: XXXX<cr></p> <p style="padding-left: 20px;">Where XXXX is the Magnitude Error Voltage, in milli-Volts (mV). 1 to 4 digits.</p>	All
MAXVF	<p>Set the Maximum Frequency for Variable Frequency Tuning</p> <p>Command: XXX_MAXVF<cr></p> <p style="padding-left: 20px;">L-Series: XXX is the maximum allowable frequency for variable frequency tuning, in 1 KHz increments, 1 to 3 digits, 100KHz to 460KHz.</p> <p style="padding-left: 20px;">1.7-2.1MHz R-Series: XXX is the maximum allowable frequency for variable frequency tuning, in 10 KHz increments, 1 to 3 digits, 1.70MKHz to 2.10MHz. (omit the decimal)</p> <p>Response: <cr></p>	1.7-2.1MHz R-Series Models L-Series Models
MINVF	<p>Set the Minimum Frequency for Variable Frequency Tuning</p> <p>Command: XXX_MINVF<cr></p> <p style="padding-left: 20px;">L-Series: XXX is the minimum allowable frequency for variable frequency tuning, in 1 KHz increments, 1 to 3 digits, 100KHz to 460KHz</p> <p style="padding-left: 20px;">1.7-2.1MHz R-Series: XXX is the minimum allowable frequency for</p>	1.7-2.1MHz R-Series Models L-Series Models

SERIAL COMMAND DETAILS		
COMMAND	COMMAND DETAIL	APPLIES TO
	<p>variable frequency tuning, in 10 KHz increments, 1 to 3 digits, 1.70MKHz to 2.10MHz. (omit the decimal)</p> <p>Response: <cr></p>	
MPL	<p>Set the MC2 Controller's Load Capacitor Preset position.</p> <p>The "MPL" command is passed thorough the RF Power Supply to the Seren IPS Inc. model MC2 Matching Network Controller. The RF Power Supply does not use or store the information.</p> <p>Note: Sending the preset position to the Seren IPS Inc. Model MC2 matching network controller from the RF Power Supply requires a serial interface connection from the RF Power Supply to the MC2 matching network controller.</p> <p>Command: XXX_MPL<cr></p> <p>Where XXX is the Load Capacitor Preset position to be stored in the MC2 Matching Network Controller's memory. 0 to 100, in percent. 1 to 3 digits.</p> <p>Response: <cr></p>	All
MPT	<p>Set the MC2 Controller's Tune Capacitor Preset position.</p> <p>The "MPT" command is passed thorough the RF Power Supply to the Seren IPS Inc. model MC2 Matching Network Controller. The RF Power Supply does not use or store the information.</p> <p>Note: Sending the preset position to the Seren IPS Inc. Model MC2 matching network controller from the RF Power Supply requires a serial interface connection from the RF Power Supply to the MC2 matching network controller.</p> <p>Command: XXX_MPT<cr></p> <p>Where XXX is the Tune Capacitor Preset position to be stored in the MC2 Matching Network Controller's memory. 0 to 100, in percent. 1 to 3 digits.</p> <p>Response: <cr></p>	All
MST	<p>Sets the RF Power Supply's Exciter Mode to "MASTER". The RF Power Supply uses its internal frequency source.</p> <p>Command: MST<cr></p> <p>Response: <cr></p>	All
NOECHO	<p>Disable ECHO mode</p> <p>Suppresses the echo of serial commands.</p> <p>Command: NOECHO<cr></p> <p>Response: <cr></p> <p>Response for accepted (acknowledged) commands is < cr> Response for invalid commands is N<cr></p>	All
+P	<p>Enable the PULSE mode</p> <p>Enables pulsing of the RF output, per the parameters specified in the programming menu or by the serial commands "D", "HT", "LP", and "HP"</p> <p>Command: +P<cr></p>	All models except R/L301, R101

SERIAL COMMAND DETAILS		
COMMAND	COMMAND DETAIL	APPLIES TO
	Response: <cr>	
-P	Disable the PULSE mode Disables pulsing of the RF output. Command: -P<cr> Response: <cr>	All models except R/L301, R101
P1?	Query Power 1 Parameter Command: P1?<cr> Response: a_b_ccc_ddd_e_f<cr > (fixed length string) Where: “a” is not implemented, always returns a “0” “b” is not implemented, always returns a “0” “ccc” is the Preset Power 1 Setpoint XXX (in Watts) “ddd” is not implemented, always returns a “000” “e” is not implemented, always returns a “0” “f” is not implemented, always returns a “0” Note: Leading zeros are replaced with the blank space character. Power Parameters are stored in the RF Power Supply’s memory and can be viewed or edited via the Programming Menu	Custom OEM Configurations
P2?	Query Power 2 Parameter Command: P2?<cr> Response: a_b_ccc_ddd_e_f<cr > (fixed length string) Where: “a” is not implemented, always returns a “0” “b” is not implemented, always returns a “0” “ccc” is the Preset Power 2 Setpoint XXX (in Watts) “ddd” is not implemented, always returns a “000” “e” is not implemented, always returns a “0” “f” is not implemented, always returns a “0” Note: Leading zeros are replaced with the blank space character. Power Parameters are stored in the RF Power Supply’s memory and can be viewed or edited via the Programming Menu.	Custom OEM Configurations
P3?	Query Power 3 Parameter Command: P3?<cr> Response: a_b_ccc_ddd_e_f<cr > (fixed length string) Where: “a” is not implemented, always returns a “0” “b” is not implemented, always returns a “0” “ccc” is the Preset Power 3 Setpoint XXX (in Watts) “ddd” is not implemented, always returns a “000”	Custom OEM Configurations

SERIAL COMMAND DETAILS		
COMMAND	COMMAND DETAIL	APPLIES TO
	<p>“e” is not implemented, always returns a “0”</p> <p>“f” is not implemented, always returns a “0”</p> <p>Note: Leading zeros are replaced with the blank space character. Power Parameters are stored in the RF Power Supply’s memory and can be viewed or edited via the Programming Menu</p>	
P4?	<p>Query Power 4 Parameter</p> <p>Command: P4?<cr></p> <p>Response: a_b_ccc_ddd_e_f<cr > (fixed length string)</p> <p>Where:</p> <p>“a” is not implemented, always returns a “0”</p> <p>“b” is not implemented, always returns a “0”</p> <p>“ccc” is the Preset Power 4 Setpoint XXX (in Watts)</p> <p>“ddd” is not implemented, always returns a “000”</p> <p>“e” is not implemented, always returns a “0”</p> <p>“f” is not implemented, always returns a “0”</p> <p>Note: Leading zeros are replaced with the blank space character. Power Parameters are stored in the RF Power Supply’s memory and can be viewed or edited via the Programming Menu</p>	Custom OEM Configurations
P5?	<p>Query Power 5 Parameter</p> <p>Command: P5?<cr></p> <p>Response: a_b_ccc_ddd_e_f<cr > (fixed length string)</p> <p>Where:</p> <p>“a” is not implemented, always returns a “0”</p> <p>“b” is not implemented, always returns a “0”</p> <p>“ccc” is the Preset Power 5 Setpoint XXX (in Watts)</p> <p>“ddd” is not implemented, always returns a “000”</p> <p>“e” is not implemented, always returns a “0”</p> <p>“f” is not implemented, always returns a “0”</p> <p>Note: Leading zeros are replaced with the blank space character. Power Parameters are stored in the RF Power Supply’s memory and can be viewed or edited via the Programming Menu</p>	Custom OEM Configurations
P6?	<p>Query Power 6 Parameter</p> <p>Command: P6?<cr></p> <p>Response: a_b_ccc_ddd_e_f<cr > (fixed length string)</p> <p>Where:</p> <p>“a” is not implemented, always returns a “0”</p> <p>“b” is not implemented, always returns a “0”</p> <p>“ccc” is the Preset Power 6 Setpoint XXX (in Watts)</p> <p>“ddd” is not implemented, always returns a “000”</p>	Custom OEM Configurations

SERIAL COMMAND DETAILS		
COMMAND	COMMAND DETAIL	APPLIES TO
	<p>“e” is not implemented, always returns a “0”</p> <p>“f” is not implemented, always returns a “0”</p> <p>Note: Leading zeros are replaced with the blank space character. Power Parameters are stored in the RF Power Supply’s memory and can be viewed or edited via the Programming Menu</p>	
PANEL	<p>Assert PANEL control</p> <p>Switches control of the unit to the front panel. Analog Interface Connector RFON* and SETPOINT signals are ignored. All serial commands except “SERIAL<cr>” or “***<cr>” are ignored.</p> <p>Note: The RF Power Supply powers-up in the last known control state. When using both SERIAL control and PANEL control, it may be advisable to issue the “***<cr>” or “SERIAL<cr>” command, then the “PANEL<cr>” command after a power down – power up cycle or before beginning a process cycle.</p> <p>Command: PANEL<cr></p> <p>Response: <cr></p>	All
PHS	<p>Query the MC2 Controller’s Phase Error Voltage</p> <p>The “PHS” command is passed through the RF Power Supply to the Seren IPS Inc. model MC2 Matching Network Controller. The RF Power Supply does not use or store the information.</p> <p>Note: Querying of the of MC2 Matching Network Controller Phase Error Voltage from the RF Power Supply requires a serial interface connection from the RF Power Supply to the MC2 matching network controller. The phase error voltage is normally associated with the operation of the matching network’s “Tune” or “series” capacitor.</p> <p>Command: PHS<cr></p> <p>Response: XXXX<cr></p> <p style="padding-left: 20px;">Where XXXX is the Phase Error Voltage, in milli-Volts (mV). 1 to 4 digits.</p>	All
PR	<p>Set the Process Pulse Frequency</p> <p>Command: XXXX_PR<cr></p> <p style="padding-left: 20px;">Where XXXX is the Process Pulse frequency in Hertz. 1 to 4 digits, 1 to 1000Hz, in 1Hz increments.</p> <p>Response: <cr></p>	Custom OEM Configurations
Q	<p>Query RF Power Supply Status (Long Form)</p> <p>Returns the current status of the RF Power Supply, in the form of a mapped string, terminated with <cr>. The mapped string includes detailed status flags and includes Power Setpoint, Forward and Reflected Power, and maximum power.</p> <p>Command: Q<cr></p> <p>Response: XXXXXXXX_aaaa_bbbb_ccc_ddd<cr></p> <p style="padding-left: 20px;">Where: aaaa is the setpoint, in Watts bbbb is the Forward Power, in Watts ccc is Reflected Power, in Watts</p>	All

SERIAL COMMAND DETAILS

COMMAND	COMMAND DETAIL	APPLIES TO
	<p>dddd is the maximum power, in Watts</p> <p>XXXXXXX is a 7-character ASCII mapped string as described below (characters are counted left-to-right):</p> <p><u>Character # 1: Control Source</u> 2 = Serial Interface, 1 = Analog Interface, 0 = Front Panel</p> <p><u>Character # 2: RF Output Regulation Feedback Source</u> 3 = Internal Sensor (RF Power Control) 0 = External FEEDBACK signal (DC Voltage Control)</p> <p><u>Character #3: Setpoint Source</u> 2 = Serial Interface, 1 = Analog Interface, 0 = Front Panel</p> <p><u>Character #4: Status Flags (bit-mapped ASCII)</u> Bit 3: 1 = RF ON, 0 = RF OFF Bit 2: 1 = Reflected Limit active, 0 = Reflected Limit inactive Bit 1: 1 = Max Power Limit active, 0 = Max Power Limit inactive Bit 0: 1 = PA Current Limit active, 0 = PA Current Limit inactive</p> <p><u>Character #5: Status Flags (bit-mapped ASCII)</u> Bit 3: 1 = RFON&OK, 0 = Ref Power alarm threshold exceeded Bit 2: 1 = Dissipation Limit active, 0 = Dissipation Limit inactive Bit 1: 1 = CEX is in Slave Mode, 0 = CEX is in Master Mode Bit 0: 1 = Pulse Mode active, 0 = Pulse Mode inactive</p> <p><u>Character #6: Status Flags (bit-mapped ASCII)</u> Bit 3: Not Used/Reserved Bit 2: Not Used/Reserved Bit 1: 1 = External Interlock OK, 0 = External Interlock open Bit 0: 1 = Temperature Alarm active, 0 = Temperature Alarm inactive</p> <p><u>Character #7: Communication Link Status</u> Bit 0: 1 = Fault, 0 = OK</p>	
R	<p>Query Status of the RF Power Supply (Short Form)</p> <p>Returns the current status of the RF Power Supply, in the form of a mapped string, terminated with <cr>. The mapped string <i>does not</i> include Power Setpoint, Forward and Reflected Power, and maximum power.</p> <p>Command: R<cr></p> <p>Response: XXXXXXXX<cr></p> <p>Where XXXXXXXX is a 7-character ASCII mapped string as described below (characters are counted left-to-right):</p>	All

SERIAL COMMAND DETAILS

COMMAND	COMMAND DETAIL	APPLIES TO
	<p><u>Character # 1: Control Source</u> 2 = Serial Interface, 1 = Analog Interface, 0 = Front Panel</p> <p><u>Character # 2: RF Output Regulation Feedback Source</u> 3 = Internal Sensor (RF Power Control) 0 = External FEEDBACK signal (DC Voltage Control)</p> <p><u>Character #3: Setpoint Source</u> 2 = Serial Interface, 1 = Analog Interface, 0 = Front Panel</p> <p><u>Character #4: Status Flags (bit-mapped ASCII)</u> Bit 3: 1 = RF ON, 0 = RF OFF Bit 2: 1 = Reflected Limit active, 0 = Reflected Limit inactive Bit 1: 1 = Max Power Limit active, 0 = Max Power Limit inactive Bit 0: 1 = PA Current Limit active, 0 = PA Current Limit inactive</p> <p><u>Character #5: Status Flags (bit-mapped ASCII)</u> Bit 3: 1 = RFON&OK, 0 = Ref Power alarm threshold exceeded Bit 2: 1 = Dissipation Limit active, 0 = Dissipation Limit inactive Bit 1: 1 = CEX is in Slave Mode, 0 = CEX is in Master Mode Bit 0: 1 = Pulse Mode active, 0 = Pulse Mode inactive</p> <p><u>Character #6: Status Flags (bit-mapped ASCII)</u> Bit 3: Not Used/Reserved Bit 2: Not Used/Reserved Bit 1: 1 = External Interlock OK, 0 = External Interlock open Bit 0: 1 = Temperature Alarm active, 0 = Temperature Alarm inactive</p> <p><u>Character #7: Communication Link Status</u> Bit 0: 1 = Fault, 0 = OK</p>	
R?	<p>Query Reflected Power</p> <p>Command: R?<cr></p> <p>Response: XXXX<cr></p> <p>Where XXXX is the current reflected power, in Watts; length: 4 characters, fixed. Leading zeros are replaced with the blank space character.</p>	All
R?W?R	<p>Concatenated R?, W?, and R Commands</p> <p>Command: R?W?R<cr></p> <p>Response: RRRR_WWWW_XXXXXXX<cr></p> <p>Where:</p> <p>RRRR is the reflected power, in Watts, length: 4 characters, fixed. Leading zeros are replaced with the blank space character</p>	All

SERIAL COMMAND DETAILS		
COMMAND	COMMAND DETAIL	APPLIES TO
	<p>WWW is forward power output, in 1-Watt increments, length: 4 characters, fixed. Leading zeros are replaced with the blank space character.</p> <p>XXXXXXX is a 7-character ASCII mapped status string as described in the R command detail.</p>	
S	<p>Disable the RF Output</p> <p>Command: S<cr></p> <p>Response: <cr></p>	All
SERIAL	<p>Assert SERIAL control.</p> <p>Switches control of the unit to the serial interface. Front panel setpoint and RF ON commands are ignored. Analog Interface Connector signals RFON* and SETPOINT are ignored.</p> <p>Note: The RF Power Supply powers-up in the last known control state. It is advisable to issue the "SERIAL<cr>" or "***<cr>" command after a power down – power up cycle or before beginning a process cycle.</p> <p>Command: SERIAL<cr></p> <p>Response: <cr></p> <p>Note: This command has the same function as the (***) command.</p>	All
SF	<p>Set Variable Frequency Tuning Strike Frequency</p> <p>Command: XXX_SF<cr></p> <p>L-Series: XXX is the desired strike (start) frequency, in KHz, 100 KHz to 460KHz,</p> <p>1.7-2.1MHz R-Series: XXX is the desired strike (start) frequency, in 10 KHz increments, 1.70MHz to 2.10MHz. (omit the decimal)</p> <p>With Variable Frequency Enabled, the unit's output frequency defaults to the Strike Frequency setting when the RF output is enabled. If reflected power is greater than the Fine Tuning Trip Level (FT command) the Variable Frequency Tuning feature will automatically adjust the RF output frequency in an attempt to match the load (minimize reflected power).</p> <p>Note: When the Variable Frequency Tuning feature is enabled, the Strike Frequency overrides the programming menu's operating frequency setting.</p> <p>Related Command: FT</p> <p>Response: <cr></p>	1.7-2.1MHz R-Series Models L-Series Models
SLV	<p>Sets the RF Power Supply's Exciter Mode to "SLAVE". The RF Power Supply uses the signal applied to the rear panel CEX IN connector as its frequency source.</p> <p>Command: SLV<cr></p> <p>Response: <cr></p>	All
TPS	<p>Query the Tune Capacitor Preset position.</p> <p>The "TPS" command is passed through the RF Power Supply to the Seren IPS Inc. model MC2 Matching Network Controller. The MC2's response is passed back through the RF Power Supply to the user's equipment. The</p>	All

SERIAL COMMAND DETAILS		
COMMAND	COMMAND DETAIL	APPLIES TO
	<p>RF Power Supply does not use or store the information.</p> <p>Note: Sending the TPS command to the Seren IPS Inc. Model MC2 matching network controller from the RF Power Supply requires a serial interface connection from the RF Power Supply to the MC2 matching network controller.</p> <p>Command: TPS<cr></p> <p>Response: XXX<cr></p> <p style="padding-left: 40px;">Where XXX is the Tune Capacitor Preset position stored in the MC2 Matching Network Controller's memory. 0 to 100, in percent. 1 to 3 digits.</p>	
UP	<p>Set RF Output Ramp Up time</p> <p>Specifies the Ramp Up time interval. When the RF output is enabled (by the front panel, analog interface or the "G" serial command), the RF output power is increased from 0 Watts to the power setpoint over the specified time interval.</p> <p>Factory default value is 1.</p> <p>Related Commands: DN, DU, EU</p> <p>RF output ramping is also configurable via the front panel programming menu.</p> <p>Command: XXXX_UP<cr></p> <p style="padding-left: 40px;">Where XXXX is the Ramp Up time interval in seconds. Range: 1 to 9999 seconds, in 1-second increments, 1 to 4 digits.</p> <p>Response: <cr></p>	All
V	<p>Set the Voltage Setpoint</p> <p>Command: XXXX_V<cr></p> <p>Where XXXX is the desired Voltage setpoint, in 1-Volt increments, 1 to 4 digits.</p> <p>Response: <cr></p> <p>Applicable To: All Models</p>	All
VX	<p>Set Variable Frequency Tuning Feature to Enabled</p> <p>Command: VX<cr></p> <p>Response: <cr></p>	1.7-2.1MHz R-Series Models L-Series Models
V?	<p>Query the Control Voltage</p> <p>Responds with the external feedback (or DC Bias) Voltage, with Probe Attenuation and scaling factors applied. R/LX01 series RF Power supplies have only one external feedback channel, therefore, this command is identical to the "0?" command. A negative (-) polarity signal is assumed.</p> <p>Command: V?</p> <p>Response: XXXX<cr></p>	All
W	<p>Set the Power Setpoint</p> <p>Command: XXXX_W<cr></p>	All

COMMAND	COMMAND DETAIL	APPLIES TO
	<p>Where XXXX is the desired setpoint, in 1-Watt increments, 1 to 4 digits.</p> <p>Note: When using low power range on models R101, R101MKII, L101, L101MKII R301, R301MKII, L301, and L301MKII, the power setpoint command string must contain a decimal point.</p> <p>Example: Desired power is 10 Watts – send the following command string: 10.0_W<cr></p> <p>Response: <cr></p>	
WG	<p>Set the Power Setpoint and Enable RF Output</p> <p>Command: XXXX_WG<cr></p> <p>Where XXXX is the desired setpoint, in 1-Watt increments, 1 to 4 digits.</p> <p>Note: When using low power range on models R101, R101MKII, L101, L101MKII R301, R301MKII, L301, and L301MKII, the power setpoint command string must contain a decimal point.</p> <p>Example: Desired power is 10 Watts – send the following command string: 10.0_WG<cr></p> <p>Response: <cr></p>	All
WS	<p>Set the Power Setpoint to 0 Watts and Disable RF Output</p> <p>Command: WS<cr></p> <p>Response: <cr></p>	All
W?	<p>Query Forward Power Output</p> <p>Command: W?</p> <p>Response: XXXX<cr></p> <p>Where XXXX is the current forward power output, in 1-Watt increments; length: 4 characters fixed. Leading zeros are replaced with the blank space character.</p>	All

Configuring Programmable Parameters

Navigating the Programming Menu

TO ENTER the programming mode, press the “PGM” button (Program/Run button – item 1) on the front panel. The legend above the button will change from “PGM” to “RUN”.

TO EXIT the programming mode, press the “RUN” button (Program/Run button – item 1) on the front panel. The legend above the button will change from “RUN” to “PGM”.

Pressing the “DOWN” button (item 2) moves down the programming menu levels.

Pressing the “UP” button (item 3) moves up the programming menu levels.

Pressing the “ENT” button (item 4) saves the programmable parameter selection. Pressing either the “UP” or “DOWN” buttons selects the next programmable parameter but does not save the parameter selection in the RF Power Supply’s memory. If changes are made and the “ENT” button *is not* pressed, the changes will not be preserved after a power-off/power-on cycle

The saved programmable parameters are recalled upon power-on.

PROGRAMMABLE PARAMETER REFERENCE CHART:

Programmable parameters are listed below. Asterisk (*) indicates factory default setting.

Note: All programmable parameters shown. Not all of the programmable parameters are applicable to all R/LX01 Series models and are notated in the “Applies To” column and in the individual parameter detail descriptions.

Programmable parameters that do not apply to your RF Power Supply type or RF Power Supply configuration will not be displayed when scrolling the menu.

PROGRAMMABLE PARAMETER REFERENCE CHART			
PARAMETER	DISPLAY LINE 3	OPTION	Applies To
Operating Frequency	FREQ XXXKHZ	100-460KHz (Default: 380KHz)	L-Series
	FREQ XXXMHZ	1.70-2.1MHz	R-Series 1.7-2.1MHz
Maximum Frequency	MAX FREQ XXXKHZ	100-460KHz (Default: 460KHz)	L-Series
	MAX FREQ XXXMHZ	1.7-2.1MHz (Default: 2.1MHz)	R-Series 1.7-2.1MHz
Minimum Frequency	MIN FREQ XXXKHZ	100-460KHz	L-Series

PROGRAMMABLE PARAMETER REFERENCE CHART			
PARAMETER	DISPLAY LINE 3	OPTION	Applies To
		(Default: 100KHz)	
	MIN FREQ XXXMHZ	1.7-2.1MHz (Default: 1.7MHz)	R-Series 1.7-2.1MHz
Control Source Note: Setting the control source to Serial Control allows scrolling and setting of serial parameters	PANEL CONTROL ANALOG CONTROL SERIAL CONTROL	PANEL* ANALOG SERIAL	All
Serial Interface Protocol	MODBUS 2W RTU MODBUS 4W RTU RS485-2 RS485-4 RS422 RS232	MODBUS 2W MODBUS 4W RS485-4 RS485-2 RS422 RS232*	All
Serial Address	ADDRESS # XX	00-99	All
Serial Baud Rate	XXXXX BAUD	115200 57600 38400 19200* 9600 4800 2400	All
Pulse Mode Note: Setting Pulse Mode to ENABLED allows scrolling and setting of pulse parameters	PULSE MODE ENABLED PULSE MODE DISABLED	ENABLED DISABLED*	All models except R/L301, R101
Pulse High Power	ENTER HI PWR XXXXW	0 Watts to Rated Power, Variable (Default: Rated Power)	OEM Pulsing R/L301MKII only
Pulse Low Power	ENTER LO PWR 0W	0 Watts to Rated Power, Variable (Default: 0 Watts)	OEM Pulsing R/L301MKII only
Pulse Frequency	FREQUENCY XXXX Hz	0 Hz to 1,000 Hz	All models
Pulse High Time	HIGH TIME 5MS	1mS to 9999mS, Variable, (Default: 5mS)	OEM Pulsing R/L301MKII only
Pulse Duty Cycle	DUTY CYCLE 50 %	0% to 100%, (Default: 50%)	All models except R/L301, R101 (Std and OEM pulsing)
Set Pulse Source	PULSE SET INTERNAL	INTERNAL*	All

PROGRAMMABLE PARAMETER REFERENCE CHART			
PARAMETER	DISPLAY LINE 3	OPTION	Applies To
	PULSE SET EXTERNAL	EXTERNAL	
Power Monitor Response	MONITOR OUTPUT PEAK MONITOR OUTPUT REAL	PEAK* REAL	All
RF Output Ramping Note: Setting RF Output Ramping to ON allows scrolling and setting of ramping parameters	RAMP MODE OFF RAMP MODE ON	OFF* ON	All
RF Output Ramp-Up Time	RAMP ON TIME 1S	1S to 9999S, Variable (Default: 1S)	All
RF Output Ramp-Down Time	RAMP OFF TIME 1S	1S to 9999S, Variable (Default: 1S)	All
Leveling Source Select Note: Setting Leveling Source to VOLTAGE CONTROL allows scrolling and setting of Probe Inversion parameters on R/L101MKII and R/L301MKII models	POWER CONTROL VOLTAGE CONTROL	Internal Power Sensor*, External Feedback Voltage	All
Probe Inversion	VLT CNTRL +PRB DB25 VLT CNTRL -PRB BNC	Probe Inverter Disabled* Probe Inverter Enabled	R/L101MKII R/L301MKII Only
Analog Voltage Range Select	RANGE 5V F.S. RANGE 10V F.S.	5VDC* 10VDC	All
Power Leveling Select	FWD POWER LEVELING LOAD POWER LEVELING	Forward Power* Load (Net) Power	All
Output Power Range Select	HIGH RANGE LOW RANGE	0-Rated Power* 0-10% Rated Power	All
Exciter Mode (Frequency Source) Select	EXCITER- MASTER EXCITER- SLAVE	Internal Source* External CEX Input	All
Maximum Output Power	ENTER MAX POWER XXXXW	1W to Rated Power (Default: Rated Power)	All
Source Menu Mode Note: setting Source Menu Mode to ON allows scrolling/setting of Source parameters	SOURCE MENU OFF SOURCE MENU ON	OFF* ON	Custom OEM Configurations

PROGRAMMABLE PARAMETER REFERENCE CHART			
PARAMETER	DISPLAY LINE 3	OPTION	Applies To
Start Power Parameter	START POWER XXXXW	1W to Rated Power (Default: 80W)	Custom OEM Configurations
Idle Power Parameter	IDLE POWER XXXXW	1W to Rated Power (Default: 50W)	Custom OEM Configurations
PBN Start I Parameter	PBN START I XXXA	1-999 Amps (Default: 150A)	Custom OEM Configurations
PWR/Beam Factor Parameter	PWR/BEAM FACTOR X	1-6 (Default: 2)	Custom OEM Configurations
Start Sense V Parameter	START SENSE V XXV	0-50 Volts (Default: 50V)	Custom OEM Configurations
Start Detect I Parameter	START DETECT I	0-50 Amps (Default 5A)	Custom OEM Configurations
Start Pulse Voltage Parameter	START PULSE V XXXXV	0-1000 Volts (Default: 1000V)	Custom OEM Configurations
Power 1 Parameter	POWER 1 XXXXW	0W to Rated Power (Default: 70W)	Custom OEM Configurations
Power 2 Parameter	POWER 2 XXXXW	0W to Rated Power (Default: 120W)	Custom OEM Configurations
Power 3 Parameter	POWER 3 XXXXW	0W to Rated Power (Default: 5W)	Custom OEM Configurations
Power 4 Parameter	POWER 4 XXXXW	0W to Rated Power (Default: 25W)	Custom OEM Configurations
Power 5 Parameter	POWER 5 XXXXW	0W to Rated Power (Default: 25W)	Custom OEM Configurations
Power 6 Parameter	POWER 6 XXXXW	0W to Rated Power (Default: 25W)	Custom OEM Configurations
Excessive RF Voltage Detection Mode	XRFV MODE ON	OFF* ON	Custom OEM Configurations
Excessive RF Voltage Foldback Point	XRFV FOLD 4200V	0 to 9999 Volts (Default: 4200V)	Custom OEM Configurations
Excessive RF Voltage Standby Power	XRFV STANDBY 300W	0W to Rated Power (Default: 300W)	Custom OEM Configurations
Excessive RF Voltage Re-Light Threshold	XRFV RELIT 2200V	0 to 9999 Volts (Default: 2200V)	Custom OEM Configurations
Zero RF Delay Time	0 RFDELAY 5S	0 to 30 Seconds (Default: 5 Seconds)	Custom OEM Configurations
Default Power Setpoint	ENT DEFAULT PWR 0	0W to Rated Power (default is 0W)	All
Front Panel Setpoint Active with Analog Control Source	PANEL SET IN REM OFF PANEL SET IN REM ON	OFF* ON	All

PROGRAMMABLE PARAMETER REFERENCE CHART			
PARAMETER	DISPLAY LINE 3	OPTION	Applies To
Selected			
Maximum DC Voltage	ENTER MAX DCV XXXXV	0 to 9999V (Default: 9999V)	All
Voltage Feedback Probe Attenuation Factor	ENT PROBE ATTEN XXXX	0 to 9999:1 (Default: 200:1)	All
Excessive Impedance Detection Enable/Disable	XIMP ON XIMP OFF	XIMP ON* XIMP OFF	Custom OEM Configurations
Excessive Impedance Trigger Level	XIMP TRIG XXXX OHMS	0 to 9999 Ohms (Default: 1000)	Custom OEM Configurations
Excessive Impedance Delay	XIMP DELAY XX S	1 to 99 Seconds (Default: 10 S)	Custom OEM Configurations
Reflected Power Alarm Threshold	REF PWR ALARM XXXW	1W to 999W (Default: See Detail)	All
Reflected Alarm ON/OFF	REF ALARM ON REF ALARM OFF	ON* OFF	All
Power Control Gain	POWER CONT GAIN XXX%	0% to 100% (Default: 100%)	All
DC Voltage Control Gain	DCV CONT GAIN XXX%	0% to 100% (Default: 100)	All
Matching Network Preset Mode Note: Setting Matching Network Preset Mode to ON allows scrolling and setting of Load and Tune Capacitor Preset Parameters	MATCH PRE INV ON MATCH PRESET ON MATCH PRESET OFF	ON and INVERTED ON OFF*	All
Load Capacitor Preset Position	LOAD PRESET XXX %	0% to 100% (Default is 50%)	All
Tune Capacitor Preset Position	TUNE PRESET XXX %	0% to 100% (Default is 50%)	All
Variable Frequency Tuning Note: Setting Variable Frequency Tuning Mode to ON allows scrolling/setting of Variable Frequency Tuning parameters	FREQ TUNE OFF FREQ TUNE ON	OFF* ON	L-Series, R-Series 1.7-2.1MHz
Coarse Tuning Trip Ratio	ENT COARSE RATIO 10	1:1 to 100:1, Variable (Default: 10:1)	L-Series, R-Series 1.7-2.1MHz

PROGRAMMABLE PARAMETER REFERENCE CHART			
PARAMETER	DISPLAY LINE 3	OPTION	Applies To
Fine Tuning Trip Level	ENT FINE TRIP 2	1 Watt to Rated Power, Variable (Default 2 Watts)	L-Series, R-Series 1.7-2.1MHz
Coarse Frequency Step	COARSE FREQ 3000HZ	1Hz to 10,000Hz, Variable (Default: 3000Hz)	L-Series, R-Series 1.7-2.1MHz
Fine Frequency Step	FINE FREQ 1000HZ	1 Hz to 10,000Hz, Variable (Default: 1000Hz)	L-Series, R-Series 1.7-2.1MHz
Strike Frequency	STRIKE FREQ XXXKHZ	MIN VAR FREQ to MAX VAR FREQ, Variable, (Default: 250KHz)	L-Series
Strike Frequency	STRIKE FREQ XXXMHZ	MIN VAR FREQ to MAX VAR FREQ, Variable, (Default: 1.8MHz)	R-Series 1.7-2.1MHz
Maximum Allowable Frequency for Variable Frequency Tuning	MAX VAR FREQ XXXKHZ	100 to 460KHz, Variable (Default: 320KHz)	L-Series
Maximum Allowable Frequency for Variable Frequency Tuning	MAX VAR FREQ XXXMHZ	1.7 to 2.1MHz, Variable (Default: 2.0MHz)	R-Series 1.7-2.1MHz
Minimum Allowable Frequency for Variable Frequency Tuning	MIN VAR FREQ XXXKHZ	100 to 460KHz, Variable (Default: 230KHz)	L-Series
Minimum Allowable Frequency for Variable Frequency Tuning	MIN VAR FREQ XXXMHZ	1.7 to 2.1MHz, Variable (Default: 1.8MHz)	R-Series 1.7-2.1MHz
Variable Frequency Tuning Feedback Mode	REFL TUNE MODE PHASE TUNE MODE + PHASE TUNE MODE -	REFL TUNE MODE* PHASE TUNE MODE + PHASE TUNE MODE -	L-Series, R-Series 1.7-2.1MHz
Communication Link Watchdog Timer Note: Setting Link Status to ON allows viewing and setting of Link Status Time Parameter	LINK STATUS OFF LINK STATUS ON	OFF* ON	All
Communications Link Status time-out value	LINK STATUS TIME 3S	0 to 30 Seconds (Default: 3S)	ALL

PROGRAMMABLE PARAMETER DETAILS:

Note: All programmable parameters shown. Not all of the programmable parameters are applicable to all R/LX01 Series models and are notated in the “Applies To” column and in the individual parameter detail descriptions.

Programmable parameters that do not apply to your RF Power Supply type or RF Power Supply configuration will not be displayed when scrolling the menu.

PROGRAMMABLE PARAMETER DETAILS		
PARAMETER	PARAMETER DETAIL	APPLIES TO
Operating Frequency:	Sets the frequency of internal RF signal source. Variable, 100KHz to 460KHz, in 1 KHz steps. Factory default setting: 380KHz Note: Custom configured units may have a restricted operating frequency range.	L-Series
	Sets the frequency of internal RF signal source. Variable, 1.70MHz to 2.1MHz, in 10 KHz steps. Factory default setting: 1.8MKHz Note: Custom configured units may have a restricted operating frequency range.	1.7-2.1MHz R-Series
Maximum Frequency:	Limits the maximum frequency of the internal RF signal source. Variable, 100KHz to 460KHz, in 1 KHz steps. Factory default setting: 460KHz Note: Custom configured units may have a restricted operating frequency range.	L-Series
	Limits the maximum frequency of the internal RF signal source. Variable, 1.70MHz to 2.1MHz, in 10 KHz steps. Factory default setting: 2.10MHz Note: Custom configured units may have a restricted operating frequency range.	1.7-2.1MHz R-Series
Minimum Frequency:	Limits the minimum frequency of the internal RF signal source. Variable, 100KHz to 460KHz, in 1 KHz steps. Factory default setting is: 100KHz Note: Custom configured units may have a restricted operating frequency range.	L-Series
	Limits the minimum frequency of the internal RF signal source. Variable, 1.70MHz to 2.1MHz, in 10 KHz steps. Factory default setting: 1.70MHz. Note: Custom configured units may have a restricted operating frequency range.	1.7-2.1MHz R-Series

PROGRAMMABLE PARAMETER DETAILS		
PARAMETER	PARAMETER DETAIL	APPLIES TO
Control Source:	Selects the interface used as the control source for the RF power supply. Factory default setting: PANEL	All
Panel Control	Selects the front panel keypad as the control source. RF ON/OFF and power setpoint commands from the analog interface are ignored. Serial interface commands, with the exception of the "SERIAL" command, are ignored. Line 2 of the front panel display shows "PANEL" as the control source.	All
Analog Control	Selects the analog interface as the control source. Front panel RF ON and power setpoint commands are ignored. Serial commands, with the exception of the "SERIAL" command, are ignored. <u>Note:</u> The front panel RF ON/OFF button can disable the RF output. Line 2 of the front panel display shows "ANALOG" as the control source.	All
Serial Control	Selects the serial interface as the control source. Front panel RF ON and power setpoint commands are ignored. RF ON/OFF and power setpoint commands from the analog interface are ignored. <u>Note:</u> The front panel RF ON/OFF button can disable the RF output. Selecting Serial Control enables access to the serial interface parameters. Line 2 of the front panel display shows "SERIAL" as the control source.	All
Serial Interface Protocol:	Selects the serial interface protocol. RS-232, RS-422, RS-485 4-Wire, RS-485 2-Wire, MODBUS 2-Wire (2W), or MODBUS 4-Wire (4W) may be selected. When RS-485, RS-422, or MODBUS is selected, access to the serial address parameter is enabled. Factory default setting: RS-232.	All
Serial Address	Selects the serial address for RS-422, RS-485, and MODBUS serial communication protocols. Address range: 00 to 99 <u>Note:</u> For RS-232 operation, the Serial Address must be set to "99" Factory default setting: 99	All
Serial Baud Rate:	Selects 2400, 4800, 9600, 19200, 38400, 57600, or 115200 Baud. Other serial communication parameters are not configurable. Parity: None; Data bits: 8; Stop Bits: 1; Handshaking: None Factory default setting: 19200 BAUD	All
Pulse Mode:	Enables or Disables internal pulsing of the RF output. When RF output is enabled, the RF output is pulsed between 0 watts and the	All models except

PROGRAMMABLE PARAMETER DETAILS		
PARAMETER	PARAMETER DETAIL	APPLIES TO
	<p>power setpoint at the rate specified by Pulse High Time and Pulse Duty Cycle parameters.</p> <p>Line 2 of the front panel display shows “PLS” as the power control mode.</p> <p>Enabling Pulse Mode allows access to pulsing parameters.</p> <p>Note: Pulse Mode is disabled when Leveling Source Select is set to Voltage Control (external feedback).</p> <p>Factory default setting: DISABLED.</p>	R/L301, R101 and units configured for OEM Pulsing
	<p>Enables or Disables internal pulsing of the RF output. When RF output is enabled, the RF output is pulsed between the Pulse Low Power parameter and the Pulse High Power parameter at the rate specified by Pulse Frequency and Pulse Duty Cycle parameters.</p> <p>Line 2 of the front panel display shows “PLS” as the power control mode.</p> <p>Enabling Pulse Mode allows access to pulsing parameters.</p> <p>Factory default setting: DISABLED.</p>	OEM Pulsing R/L301MKII only
Pulse High Power:	<p>Sets the pulse high power level. Variable, 1 Watt to rated forward output power, in 1-Watt increments.</p> <p>Factory default setting is rated forward power.</p>	All models except R/L301, R101
Pulse Low Power:	<p>Sets the pulse low power level. Variable, 0 Watts to rated forward output power, in 1-Watt increments.</p> <p>Factory default setting: 0 Watts.</p>	OEM Pulsing R/L301MKII only
Pulse Frequency	<p>Sets the pulse repetition rate in Hertz. The pulse frequency is variable from 0 Hz to 1,000 Hz, in 1-Hz increments.</p> <p>Factory default setting: 1,000 Hz</p>	All models except R/L301, R101 and units configured for OEM Pulsing
Pulse High Time:	<p>Sets the high pulse duration, in milliseconds. The pulse high time can be varied from 1mS to 9999mS, in 1-mS increments.</p> <p>Factory default setting: 5mS.</p>	OEM Pulsing R/L301MKII only
Pulse Duty Cycle:	<p>Sets the “ON” duration of the RF output pulse, in relation to the pulse repetition rate. The “ON” duration can be varied from 1% to 100%, in 1% increments.</p> <p>Factory default setting: 50%.</p>	All models except R/L301, R101
Pulse Source	<p>Selects the pulse source. Set to “INTERNAL” to use the unit’s internal pulse generator. Set to “EXTERNAL” to use the signal applied to the Analog Interface connector’s “GATE” signal as the pulse source.</p> <p>Note: When the Pulse Source is set to EXTERNAL, the Pulse Frequency, Pulse High Time, Pulse Low Time, and Pulse Duty Cycle parameters are ignored.</p> <p>Factory default setting: INTERNAL</p>	All models

PROGRAMMABLE PARAMETER DETAILS		
PARAMETER	PARAMETER DETAIL	APPLIES TO
Power Monitor Response	<p>Selects the Analog Interface connector's Power Monitor outputs response when Pulse Mode is enabled.</p> <p>PEAK Response: The Analog Interface power monitors deliver a steady-state signal, equivalent to the peak forward RF output power and peak reflected power.</p> <p>REAL Response: The Analog Interface forward power monitor and reflected power monitor signals track the RF output envelope.</p> <p>Factory default setting: PEAK</p>	All models
Ramp Mode	<p>Enables or disables ramping of the RF output when the RF output is enabled or disabled.</p> <p>Setting RAMP MODE to "ON" allows access to the ramping parameters.</p> <p>Note: Ramp Mode is disabled when Pulse Mode is active or when the Leveling Source Select is set to Voltage Control (external feedback).</p> <p>RF output Ramp Mode is also configurable via the serial interface.</p> <p>Factory default setting: OFF</p>	All
Ramp On Time	<p>Specifies the Ramp-Up time interval. When the RF output is enabled (by the front panel, analog interface or serial command), the RF output power is increased from 0 Watts to the power setpoint over the specified time interval.</p> <p>RF output Ramp-Up time is also configurable via the serial interface.</p> <p>Ramp-Up Time Range: 1 to 9999 seconds, in 1-second increments.</p> <p>Factory default setting: 1S</p>	All
Ramp Off Time	<p>Specifies the Ramp-Down time interval. When the RF output is enabled (by the front panel, analog interface or serial command), the RF output power is decreased from the power setpoint to 0 Watts over the specified time interval.</p> <p>RF output Ramp-Down time is also configurable via the serial interface.</p> <p>Ramp-Up Time Range: 1 to 9999 seconds, in 1-second increments.</p> <p>Factory default setting: 1S</p>	All
Leveling Source Select:	<p>Selects the feedback source used to regulate the RF output level.</p> <p>Enabling Pulse Mode allows access to pulsing parameters.</p> <p>Factory default setting: POWER CONTROL</p>	All

PROGRAMMABLE PARAMETER DETAILS		
PARAMETER	PARAMETER DETAIL	APPLIES TO
POWER CONTROL:	<p>Uses the RF Power Supply's internal power sensor as the feedback source for regulating the RF output level.</p> <p>Line 1 of the front panel display indicates forward power setpoint, in Watts, when the RF output is off, indicates Forward or Load power when the RF output is enabled.</p> <p>Line 2 of the front panel display indicates "PWR" when POWER CONTROL is selected.</p>	All
VOLTAGE CONTROL:	<p>Uses the analog interface connector's FEEDBACK signal as the feedback source for regulating the RF output level.</p> <p>Line 1 of the front panel display indicates the voltage setpoint, in Volts, when the RF output is off, indicates Probe Voltage when the RF output is enabled.</p> <p>Line 2 of the front panel display indicates "VLT" when VOLTAGE CONTROL is selected.</p> <p>Note: Setting the Leveling Source to VOLTAGE CONTROL disables Pulsing and Ramping modes.</p> <p>Note: Setting the Leveling Source to VOLTAGE CONTROL enables viewing and configuring of the Probe Inverter feature on Models R/L101MKII and R/L301MKII.</p>	All
Probe Inversion	<p>Enables or disables internal routing of the output of the DCP Connector probe inverter feature to the Analog Interface connector's FEEDBACK signal.</p> <p>Note: Only available on R/L101MKII and R/L301MKII models with Software Version 9.0J3 and later.</p> <p>Factory default setting: VLT CNTRL +PRB DB25</p>	R/L101MKII, R/L301MKII Only
VLT CNTRL +PRB DB25	<p>Disables the probe inversion feature.</p> <p>Any signal applied to the rear panel DCP connector is ignored.</p> <p>A positive (+) polarity external feedback (probe) signal applied to the Analog Interface connector (type DB25) FEEDBACK signal (pin 12) is used for external feedback when the Leveling Source Select parameter is set to Voltage Control.</p>	R/L101MKII, R/L301MKII Only

PROGRAMMABLE PARAMETER DETAILS		
PARAMETER	PARAMETER DETAIL	APPLIES TO
VLT CNTRL -PRB BNC	<p>Routes the output of the probe inverter to the Analog Interface connector's FEEDBACK SIGNAL.</p> <p>A negative (-) polarity external feedback signal applied to the DCP connector (type BNC) is used for external feedback when the Leveling Source Select parameter is set to Voltage Control.</p> <p>Note: The output of the probe inverter <i>is present</i> at pin 12 (FEEDBACK signal) of the Analog Interface connector. This signal may be used by the user's system for remote monitoring.</p> <p>Caution: When using the probe inverter signal at pin 12 of the Analog Interface connector (FEEDBACK signal) for remote monitoring purposes, take care to properly shield the connection and do not short the signal to ground – the RF Power supply is using this signal to regulate its power output. Applying noise or other signals sources to the FEEDBACK signal pin may cause the unit's output to behave erratically or produce unexpected process results.</p>	R/L101MKII, R/L301MKII Only
Analog Voltage Range Select:	<p>Selects the Full-Scale voltage for the analog interface's SETPOINT and FEEDBACK inputs, and the analog interface's FWD MON (Forward Power monitor) and REFP MON (Reflected Power monitor) outputs.</p> <p>Factory default setting: RANGE 5V F.S.</p>	All
RANGE 5V F.S.	Sets +5.0VDC as the full-scale voltage.	All
RANGE 10V F.S.	Sets +10.0VDC as the full-scale voltage.	All
Power Leveling Select:	<p>Selects the method used to regulate the unit's RF output power when Leveling Source Select is set to POWER CONTROL.</p> <p>Factory default setting: FWD POWER LEVELING</p>	All
FWD POWER LEVELING	Regulates the RF output power based solely on the forward power feedback signal. The front panel display and the analog interface's FWD MON (forward power monitor) signal indicate the amount of forward power delivered to the load.	All
LOAD POWER LEVELING	Regulates the RF output power based on the net power delivered to the load. (forward power – reflected power = net power). The front panel display and the analog interface's FWD MON (forward power monitor) signal indicate the amount of net power delivered to the load.	All
Output Power Range Select:	<p>HIGH RANGE sets the unit's output power range from 0% to 100% of the unit's rated power output, with standard power setpoint and power metering resolution.</p> <p>LOW RANGE sets the unit's output power range from 0% to 10% of the unit's rated power output, with enhanced power setpoint and</p>	All

PROGRAMMABLE PARAMETER DETAILS		
PARAMETER	PARAMETER DETAIL	APPLIES TO
	<p>power metering resolution.</p> <p>Factory default setting: HIGH RANGE</p>	
Exciter Mode (Frequency Source) Select:	<p>EXCITER- MASTER: The unit uses its internal frequency source to generate the RF output signal. In “master” mode, the internal frequency source is available at the CEX OUT connector on the rear panel.</p> <p>EXCITER- SLAVE: The unit uses the rear panel CEX IN signal as the frequency source for the RF output signal. “Slave” Mode is used in systems with multiple RF power supplies; with one RF power supply as the master and the other power supplies operating as “slaves”. This configuration is used to keep the power supplies synchronized, thus preventing or minimizing RF circulating currents within the processing system. In “slave” mode, the CEX IN signal is routed to the rear panel CEX OUT connector.</p> <p>Factory default setting: EXCITER - MASTER</p>	All
Maximum Output Power:	<p>Allows the user limit the maximum RF output power. Limit is adjustable between 1 Watt and rated output power, in 1-Watt increments. When the output power setpoint is equal to the MAX POWER value, “MAX” is indicated on the front panel display, line 2, right-hand side.</p> <p>Factory default setting: Rated Output Power.</p>	All
Source Menu Enable/Disable	<p>Enables display of the Source Parameter menu options. When set to “ON”, the Source Parameters are displayed as the next steps in the menu. Users may scroll the source parameters with the menu UP/DOWN buttons and adjustments to the settings may be preformed. When set to “OFF”, the Source Parameters are not displayed and pressing the menu UP/DOWN buttons skips over the source parameters.</p> <p>The Source Parameters do not have any direct effect on the operation or performance of the RF Power Supply. The Source Parameter data is stored within the unit’s non-volatile memory, for retrieval by commands sent to the unit via the serial interface. Refer to the Serial Interface Operation section for serial command details.</p> <p>Factory default setting: SOURCE MENU ENABLED</p>	Custom OEM Configurations
Start Power Parameter	<p>Start Power recallable parameter. Variable, 1W to rated output power, in 1-Watt increments.</p> <p>Use the serial command “CGP?” to read the current parameter value. Refer to the Serial Commands section for a detailed explanation of the “CGP?” command.</p> <p>Related menu item: Source Menu Enable/Disable</p> <p>Factory default setting: 80W</p>	Custom OEM Configurations
Idle Power Parameter	<p>Idle Power recallable parameter. Variable, 1W to rated output</p>	Custom OEM

PROGRAMMABLE PARAMETER DETAILS		
PARAMETER	PARAMETER DETAIL	APPLIES TO
	<p>power, in 1-Watt increments.</p> <p>Use the serial command “CGP?” to read the current parameter value. Refer to the Serial Commands section for a detailed explanation of the “CGP?” command.</p> <p>Related menu item: Source Menu Enable/Disable</p> <p>Factory default setting: 50W</p>	Configurations
PBN Start I Parameter	<p>PBN Start I recallable parameter. Variable, 1-999 Amps, in 1-Amp increments.</p> <p>Use the serial command “CGP?” to read the current parameter value. Refer to the Serial Commands section for a detailed explanation of the “CGP?” command.</p> <p>Related menu item: Source Menu Enable/Disable</p> <p>Factory default setting: 150A</p>	Custom OEM Configurations
PWR/Beam Factor Parameter	<p>PWR/Beam Factor recallable parameter. Variable, 1 to 6, in increments of 1.</p> <p>Use the serial command “CGP?” to read the current parameter value. Refer to the Serial Commands section for a detailed explanation of the “CGP?” command.</p> <p>Related menu item: Source Menu Enable/Disable</p> <p>Factory default setting: 2</p>	Custom OEM Configurations
Start Sense V Parameter	<p>Start Sense V recallable parameter. Variable 0 to 50 Volts, in 1-volt increments.</p> <p>Use the serial command “CSP?” to read the current parameter value. Refer to the Serial Commands section for a detailed explanation of the “CSP?” command.</p> <p>Related menu item: Source Menu Enable/Disable</p> <p>Factory default setting: 50V</p>	Custom OEM Configurations
Start Detect I Parameter	<p>Start Detect I recallable parameter. Variable, 0 to 50 Amps, in 1-Amp increments.</p> <p>Use the serial command “CSP?” to read the current parameter value. Refer to the Serial Commands section for a detailed explanation of the “CSP?” command.</p> <p>Related menu item: Source Menu Enable/Disable</p> <p>Factory default setting: 5A</p>	Custom OEM Configurations
Start Pulse Voltage Parameter	<p>Start Pulse Voltage recallable parameter. Variable, 1 to 1000 Volts, in 1-Volt increments.</p> <p>Use the serial command “CSP?” to read the current parameter value. Refer to the Serial Commands section for a detailed explanation of the “CSP?” command.</p> <p>Related menu item: Source Menu Enable/Disable</p> <p>Factory default setting: 1000V</p>	Custom OEM Configurations
Power 1 Parameter	<p>Power 1 recallable parameter. Variable, 0 Watts to rated output power, in 1-watt increments.</p> <p>Use the serial command “P1?” to read the current parameter value.</p>	Custom OEM Configurations

PROGRAMMABLE PARAMETER DETAILS		
PARAMETER	PARAMETER DETAIL	APPLIES TO
	<p>Refer to the Serial Commands section for a detailed explanation of the "P1?" command.</p> <p>Related menu item: Source Menu Enable/Disable</p> <p>Factory default setting: 70W</p>	
Power 2 Parameter	<p>Power 2 recallable parameter. Variable, 0 Watts to rated output power, in 1-watt increments.</p> <p>Use the serial command "P2?" to read the current parameter value. Refer to the Serial Commands section for a detailed explanation of the "P2?" command.</p> <p>Related menu item: Source Menu Enable/Disable</p> <p>Factory default setting: 120W</p>	Custom OEM Configurations
Power 3 Parameter	<p>Power 3 recallable parameter. Variable, 0 Watts to rated output power, in 1-watt increments.</p> <p>Use the serial command "P3?" to read the current parameter value. Refer to the Serial Commands section for a detailed explanation of the "P3?" command.</p> <p>Related menu item: Source Menu Enable/Disable</p> <p>Factory default setting: 5W</p>	Custom OEM Configurations
Power 4 Parameter	<p>Power 4 recallable parameter. Variable, 0 Watts to rated output power, in 1-watt increments.</p> <p>Use the serial command "P4?" to read the current parameter value. Refer to the Serial Commands section for a detailed explanation of the "P4?" command.</p> <p>Related menu item: Source Menu Enable/Disable</p> <p>Factory default setting: 25W</p>	Custom OEM Configurations
Power 5 Parameter	<p>Power 5 recallable parameter. Variable, 0 Watts to rated output power, in 1-watt increments.</p> <p>Use the serial command "P5?" to read the current parameter value. Refer to the Serial Commands section for a detailed explanation of the "P5?" command.</p> <p>Related menu item: Source Menu Enable/Disable</p> <p>Factory default setting: 25W</p>	Custom OEM Configurations
Power 6 Parameter	<p>Power 6 recallable parameter. Variable, 0 Watts to rated output power, in 1-watt increments.</p> <p>Use the serial command "P6?" to read the current parameter value. Refer to the Serial Commands section for a detailed explanation of the "P6?" command.</p> <p>Related menu item: Source Menu Enable/Disable</p> <p>Factory default setting: 25W</p>	Custom OEM Configurations
Default Power Setting:	<p>Allows the user to configure the default power-on output power setpoint. Variable, 0 Watts to rated power, in 1-Watt increments.</p> <p>Factory default setting: 0 Watts.</p>	All

PROGRAMMABLE PARAMETER DETAILS		
PARAMETER	PARAMETER DETAIL	APPLIES TO
Front Panel Setpoint Active with Analog Control Selected:	<p>When this parameter is set to PANEL SET IN REM OFF, and the control source is set to “ANALOG” (via the front panel or through the serial interface), the power setpoint cannot be adjusted from the front panel. The power setpoint is adjusted via the analog interface connector’s SETPOINT signal.</p> <p>When this parameter is set to PANEL SET IN REM ON, and the control source is set to “ANALOG” (via the front panel or through the serial interface), the front panel power setpoint adjustment is active. The analog interface connector’s SETPOINT signal is ignored.</p> <p>This parameter has no effect if the control source is set to SERIAL or PANEL.</p> <p>Factory default setting: PANEL SET IN REM OFF.</p>	All
Maximum DC Voltage	<p>Allows the user limit the RF output, based on the external feedback signal. The MAX DCV limit is active regardless of the Leveling Source Select parameter setting (POWER CONTROL or VOLTAGE CONTROL)</p> <p>Limit is adjustable between 1 Watt and 9999V, in 1-Volt increments. When the sensed external feedback voltage is equal to the MAX DCV value, “MAX” is indicated on the front panel display, line 2, right-hand side.</p> <p>Factory default setting: 9999V.</p> <p>Related Parameters: Voltage Feedback Probe Attenuation Factor</p>	
Voltage Feedback Probe Attenuation Factor:	<p>Used when regulating the unit’s RF output with an external feedback signal. Setting the attenuation factor to match the external system’s probe attenuation factor allows the RF Power Supply to directly display the feedback signal in Volts.</p> <p>External feedback voltages are derived from the processing system and can range from tens of Volts to thousands of Volts. Because it is not practical or safe to use high-voltage control signals, and the RF Power Supply’s maximum external feedback input voltage is 10VDC, an attenuator probe is used in most systems.</p> <p>The external system’s attenuator probe is calibrated, and the calibration is specified as a ratio. Adjust the RF Power Supply’s voltage feedback probe attenuation factor to match the system’s voltage probe attenuation ratio.</p> <p>Connect the external feedback signal to the Analog Interface Connector’s FEEDBACK signal input.</p> <p>Factory default value: 200:1</p>	All
Excessive Impedance Detection (XIMP) Enable/Disable	<p>Excessive Impedance Detection (XIMP) feature is designed to detect a “no plasma” condition in the user’s plasma chamber and disable the RF output.</p>	Custom OEM Configurations

PROGRAMMABLE PARAMETER DETAILS		
PARAMETER	PARAMETER DETAIL	APPLIES TO
	<p>When enabled (on), the RF Power Supply calculates the plasma impedance based on the formula:</p> $E^2/P = Z$ <p>Where P is the forward RF power output, E is the external feedback voltage from an external RF probe (installed in an external impedance matching network) applied to the Analog Interface FEEDBACK signal, and Z is the calculated impedance.</p> <p>When the RF output is enabled, the plasma impedance (Z) is continuously calculated. After a short delay (XIMP Delay) to allow time for the plasma to strike and stabilize, the plasma impedance is continuously compared against the Excessive Impedance Trigger level (XIMP Trigger).</p> <p>If the calculated plasma impedance (Z) is greater than the Excessive Impedance Trigger level (XIMP Trigger), an "XIMP" alarm message appears on line 2 of the front panel display. If the Excessive impedance condition persists after the XIMP delay period has expired, the RF Power Supply's RF output is disabled. The "XIMP" alarm message clears when the "XIMP" condition is removed or when the RF output is disabled and re-enabled.</p> <p>When disabled (off), the plasma impedance is not calculated and the XIMP Trigger level is ignored.</p> <p>Factory default setting: XIMP ON</p>	
Excessive Impedance (XIMP) Trigger	<p>Calculated plasma impedances greater than the trigger value will disable the RF power Supply's output. Variable, 1 Ohm to 9999 Ohms, in 1-Ohm increments.</p> <p>Factory default setting: XIMP TRIGGER 1000 OHMS</p>	Custom OEM Configurations
Excessive Impedance (XIMP) Delay	<p>Sets the time delay between RF ON and the comparison of plasma impedance and XIMP Trigger level. Variable, 1 to 99 seconds, in 1-second increments.</p> <p>Factory default setting: 10 S</p>	Custom OEM Configurations
Reflected Power Alarm Threshold:	<p>Allows the user to set a threshold for indicating a high-reflected power condition. Adjustable between 1 and 999 Watts, in 1-Watt increments.</p> <p>When the alarm threshold is met or exceeded, "REF" is indicated on line 2 of the front panel display <i>and</i> the status of the analog interface connector RFENABLED* signal (pin 8) is changed from a TTL logic low (0) state to a TTL logic high (1) state.</p> <p>To disable changing of the RFENABLED* signal status, set the alarm threshold greater than the unit's maximum reflected power limit <i>or</i> set the reflected alarm (REF ALARM) parameter to OFF</p> <p>Note: The reflected power alarm message (REF) will always be displayed if the unit's maximum reflected power limit is reached.</p> <p>Related menu item: Reflected Alarm ON/OFF</p> <p>Factory default setting: Maximum reflected power limit. See the Technical Specifications section for your RF Power Supply Model type.</p>	All

PROGRAMMABLE PARAMETER DETAILS		
PARAMETER	PARAMETER DETAIL	APPLIES TO
Reflected Alarm ON/OFF:	<p>REF ALARM ON: Enables changing of the analog interface connector's RFENABLED* signal (pin 8) state when the maximum reflected power limit is reached or when the Reflected Power Alarm threshold has been reached.</p> <p>REF ALARM OFF: Disables changing of the analog interface connector's RFENABLED* signal (pin 8) state when the maximum reflected power limit is reached or when the Reflected Power Alarm threshold has been reached.</p> <p>Related menu item: Reflected Power Alarm Threshold</p> <p>Factory default setting: REF ALARM ON</p>	All
Power Control Gain	<p>Digital Control Loop Gain – Power Control Modes. Setting the gain value to less than 100% will result in a loss of power setpoint accuracy but may help to reduce plasma/process noise issues. This parameter rarely requires adjustment from the factory default value.</p> <p>Factory default setting: 100%</p>	All
DC Voltage Control Gain	<p>Digital Control Loop Gain – Voltage Control Modes. Setting the gain value to less than 100% will result in a loss of voltage setpoint accuracy but may help to reduce plasma/process noise issues. This parameter rarely requires adjustment from the factory default value.</p> <p>Factory default setting is 100%</p>	All
Matching Network Preset Mode:	<p>Enables or disables the Matching Network Preset feature and configures the behavior of the analog interface connector RFENABLED* signal (pin 8) when the Matching Network Preset feature is enabled.</p> <p><u>Note:</u> This feature is designed for use with the Seren IPS Inc. MC2 matching network controller and AT-Series automatic matching networks. The MC2 controller, AT-Series matching networks, and interface cabling are not supplied with the RF Power Supply and must be purchased separately.</p> <p>Related menu items: Load Capacitor Preset Position, Tune Capacitor Preset Position</p> <p>Factory default setting: DISABLE MATCH PRESET</p>	All
MATCH PRE INV ON	<p>When the RF output is disabled, the matching network preset position voltages are present on the analog interface connector's FWD MON and REFP MON signal pins.</p> <p>Analog interface connector RFENABLED* signal (pin 8) outputs a TTL logic high (1) state when the RF output is enabled and the reflected power threshold alarm has not been exceeded.</p> <p>Analog interface connector RFENABLED* signal (pin 8) outputs a TTL logic low (0) state when the RF output is disabled or when the reflected power threshold alarm has been exceeded.</p>	All

PROGRAMMABLE PARAMETER DETAILS		
PARAMETER	PARAMETER DETAIL	APPLIES TO
MATCH PRESET ON	<p>When the RF output is disabled, the matching network preset position voltages are present on the analog interface connector's FWD MON and REFP MON signal pins.</p> <p>Analog interface connector RFENABLED* signal (pin 8) outputs a TTL logic low (0) state when the RF output is enabled and the reflected power threshold alarm has not been exceeded.</p> <p>Analog interface connector RFENABLED* signal (pin 8) outputs a TTL logic high (1) state when the RF output is disabled or when the reflected power threshold alarm has been exceeded.</p>	All
MATCH PRESET OFF	Disables the Matching Network Preset feature.	All
Load Capacitor Preset Position:	<p>Sets the Load Capacitor preset position voltage output for an external matching network. Adjustable from 0% (0.0VDC output) to 100% (+5.0VDC), in 1% (50mV) increments.</p> <p>With Matching Network Preset Mode enabled and the RF output disabled, the Load Capacitor preset position voltage (0 to +5.0VDC) is present at the analog interface connector's REFP MON (reflected power monitor) signal (pin 11).</p> <p><u>Note:</u> this feature designed for use with the Seren IPS Inc. MC2 matching network controller and AT-Series automatic matching networks.</p> <p>Related menu item: Matching Network Preset Mode Factory default setting: 50%</p>	All
Tune Capacitor Preset Position:	<p>Sets the Tune Capacitor preset position voltage output for an external matching network. Adjustable from 0% (0.0VDC output) to 100% (+5.0VDC), in 1% (50mV) increments.</p> <p>With Matching Network Preset Mode enabled and the RF output disabled, the Tune Capacitor preset position voltage (0 to +5.0VDC) is present at the analog interface connector's FWD MON (forward power monitor) signal (pin 10).</p> <p><u>Note:</u> this feature designed for use with the Seren IPS Inc. MC2 matching network controller and AT-Series automatic matching networks.</p> <p>Related menu item: Matching Network Preset Mode Factory default setting is 50%</p>	All
Variable Frequency Tuning Enable/Disable:	<p>Enables or disables the Variable Frequency Tuning feature. When enabled, the Variable Frequency Tuning feature monitors the reflected power and automatically adjusts the RF output frequency to minimize the reflected power. The configurable parameters in levels 21a through 21g allow the operator to tailor the Variable Frequency Tuning algorithm's performance to the operator's system.</p>	L-Series 1.7-2.1MHz R-Series

PROGRAMMABLE PARAMETER DETAILS		
PARAMETER	PARAMETER DETAIL	APPLIES TO
	<p>Note: When the Variable Frequency Tuning feature is enabled, the Variable Frequency Tuning feature <i>and</i> the VFT Strike Frequency override the programming menu's operating frequency setting.</p> <p>Factory default setting: FREQ TUNE OFF</p>	
Coarse Tuning Trip Ratio:	<p>A ratio of Reflected Power to Forward Power (Reflected Power: Forward Power), XXX:1, where XXX is a user-configurable value.</p> <p>The Coarse Tuning Trip Ratio is a trigger used to switch between the coarse frequency stepping and the fine frequency stepping of the Variable Frequency Tuning (VFT) feature. Coarse frequency stepping is active when the reflected power to forward power ratio is greater than the VFT Coarse Tuning Trip Ratio setting. Fine frequency stepping is active when the reflected power to forward power ratio is equal to or less than the VFT Coarse Tuning Trip Ratio setting. Range: 1:1 to 100:1.</p> <p>Factory default ratio setting : 10:1</p>	L-Series 1.7-2.1MHz R-Series
Fine Tuning Trip Level:	<p>If reflected power level is less than or equal to the Fine Tuning Trip Level, the Variable Frequency Tuning feature stops attempting to match to the load (minimize reflected power). If reflected power is greater than the Fine Tuning Trip Level, the Variable Frequency Tuning feature adjusts the RF output frequency to minimize reflected power. Range: 1 Watt to 99 Watts.</p> <p>Factory default setting: 2 Watts.</p>	L-Series 1.7-2.1MHz R-Series
Coarse Frequency Tuning Step:	<p>When the Reflected Power to Forward Power ratio is greater than the Coarse Tuning Trip Ratio, the Variable Frequency Tuning feature increments or decrements the RF output frequency by the Coarse Frequency Tuning Step value, attempting to match to the load (minimize reflected power).</p> <p>The Coarse Frequency Tuning Step value is configurable, from 1 Hz 10,000 Hz in 1 Hz increments.</p> <p>Factory default step setting: 3000 Hz.</p>	L-Series 1.7-2.1MHz R-Series
Fine Frequency Tuning Step:	<p>When the Reflected Power to Forward Power ratio is less than or equal to the Coarse Tuning Trip Ratio, the Variable Frequency Tuning feature increments or decrements the RF output frequency by the Fine Frequency Tuning Step value, attempting to match to the load (minimize reflected power).</p> <p>The Fine Frequency Tuning Step value is configurable, from 1 Hz 10,000 Hz in 1 Hz increments.</p> <p>Factory default step setting is 1000 Hz.</p>	L-Series 1.7-2.1MHz R-Series
Strike Frequency:	<p>With Variable Frequency Enabled, the unit's output frequency defaults to the Strike Frequency setting when the RF output is enabled.</p>	L-Series

PROGRAMMABLE PARAMETER DETAILS		
PARAMETER	PARAMETER DETAIL	APPLIES TO
	<p>If reflected power is greater than the Fine Tuning Trip Level, the Variable Frequency Tuning feature will automatically adjust the RF output frequency in an attempt to match the load (minimize reflected power). The Strike Frequency value must be between the Minimum Allowable Frequency and the Maximum Allowable Frequency values.</p> <p>Note: When the Variable Frequency Tuning feature is enabled, the Variable Frequency Tuning feature <i>and</i> the Strike Frequency override the programming menu's operating frequency setting.</p> <p>Strike frequency is configurable from 100 KHz to 460KHz, in 1 KHz increments.</p> <p>Factory default setting is 250 KHz</p>	
Strike Frequency:	<p>With Variable Frequency Enabled, the unit's output frequency defaults to the Strike Frequency setting when the RF output is enabled.</p> <p>If reflected power is greater than the Fine Tuning Trip Level, the Variable Frequency Tuning feature will automatically adjust the RF output frequency in an attempt to match the load (minimize reflected power). The Strike Frequency value must be between the Minimum Allowable Frequency and the Maximum Allowable Frequency values.</p> <p>Note: When the Variable Frequency Tuning feature is enabled, the Variable Frequency Tuning feature <i>and</i> the Strike Frequency override the programming menu's operating frequency setting.</p> <p>Strike frequency is configurable from 1.70MHz to 2.10MHz, in 1 KHz increments.</p> <p>Factory default setting is 1.8MHz</p>	1.7-2.1MHz R-Series
Maximum Allowable Frequency for Variable Frequency Tuning:	<p>The Maximum Allowable Frequency limits the highest frequency the Variable Frequency Tuning feature may use while attempting to match the load.</p> <p>The Maximum Allowable Frequency is configurable from 100 KHz to 460KHz, in 1 KHz increments.</p> <p>Factory default setting is 460 KHz</p>	L-Series
Maximum Allowable Frequency for Variable Frequency Tuning:	<p>The Maximum Allowable Frequency limits the highest frequency the Variable Frequency Tuning feature may use while attempting to match the load.</p> <p>The Maximum Allowable Frequency is configurable from 1.70 MHz to 2.10MHz, in 10 KHz increments.</p> <p>Factory default setting: 2.10MHz</p>	1.7-2.1MHz R-Series
Minimum Allowable Frequency for Variable	<p>The Minimum Allowable Frequency limits the lowest frequency the Variable Frequency Tuning feature may use while attempting</p>	L-Series

PROGRAMMABLE PARAMETER DETAILS		
PARAMETER	PARAMETER DETAIL	APPLIES TO
Frequency Tuning:	<p>to match the load</p> <p>The Minimum Allowable Frequency is configurable from 100 KHz to 460KHz, in 1 KHz increments.</p> <p>Factory default setting is 100 KHz</p>	
Minimum Allowable Frequency for Variable Frequency Tuning:	<p>The Minimum Allowable Frequency limits the lowest frequency the Variable Frequency Tuning feature may use while attempting to match the load</p> <p>The Minimum Allowable Frequency is configurable from 1.70 MHz to 2.10 MHz, in 10 KHz increments.</p> <p>Factory default setting is 1.70 MHz</p>	1.7-2.1MHz R-Series
Variable Frequency Tuning Feedback Mode	<p>Selects the method of feedback for the Variable Frequency Tuning feature.</p> <p>Factory Default setting: REFL TUNE MODE</p>	L-Series 1.7-2.1MHz R-Series
REFL TUNE MODE	<p>Uses the RF Power Supply's internal reflected power sensor as the feedback source for Variable Frequency Tuning.</p>	L-Series 1.7-2.1MHz R-Series
PHASE TUNE MODE +	<p>Uses a voltage signal from an external phase detector to control Variable Frequency Tuning feature. The external phase detector's output is applied to the Analog Interface connector's PHASE input signal. When the PHASE signal is 0.00VDC, the RF Power Supply assumes reflected power is at minimum and stops the tuning process.</p> <p>Output frequency increases with a positive (+) polarity input signal.</p>	L-Series 1.7-2.1MHz R-Series
PHASE TUNE MODE -	<p>Uses a voltage signal from an external phase detector to control Variable Frequency Tuning feature. The external phase detector's output is applied to the Analog Interface connector's PHASE input signal. When the PHASE signal is 0.00VDC, the RF Power Supply assumes reflected power is at minimum and stops the tuning process.</p> <p>Output frequency increases with a negative (-) polarity input signal.</p>	L-Series 1.7-2.1MHz R-Series
Communications Link Status Watchdog Timer	<p>Setting the LINK STATUS parameter to ON enables a watchdog timer function for the serial communications link (RS-232/422/485).</p> <p>Periodic polling of the RF Power Supply's status by the user's system, using the "Q" serial command, resets the watchdog timer. If the watchdog timer expires before a "Q" command is received, the RF output is disabled, the Link Status flag is set to "fault" (see serial command "Q") and the unit's control source is set to PANEL.</p> <p>Issuing a "Q" command to the RF Power Supply after the watchdog timer has expired returns the status string, with the Link</p>	All

PROGRAMMABLE PARAMETER DETAILS		
PARAMETER	PARAMETER DETAIL	APPLIES TO
	<p>Status flag set to "fault"</p> <p>Issuing the "SERIAL" or "****" command clears the Links Status flag and polling of the RF Power Supply's status must resume or the watchdog timer will expire, disable the RF output, set the control source to "PANEL", and re-set the Link Status Flag to "fault"</p> <p>Note: The polling period must be less than the value of the Communication s Link Status Time.</p> <p>Note: Setting Link Status to ON allows viewing and setting of Link Status Time parameter</p> <p>Related menu item: Communications Link Status Time</p> <p>Factory default setting: LINK STATUS OFF</p>	
Communications Link Status Time	<p>The communications LINK STATUS TIME value sets the longest time the unit may operate without receiving a "Q" command via the serial communication link.</p> <p>Configurable from 0 seconds to 30 seconds in 1-second increments.</p> <p>Related menu item: Communication Link Status Watchdog Timer</p> <p>Factory default setting: 3S</p>	All

Rear Panel Controls and Connections

Models R101, R101MKII, R301, R301MKII, L301, L301MKII:

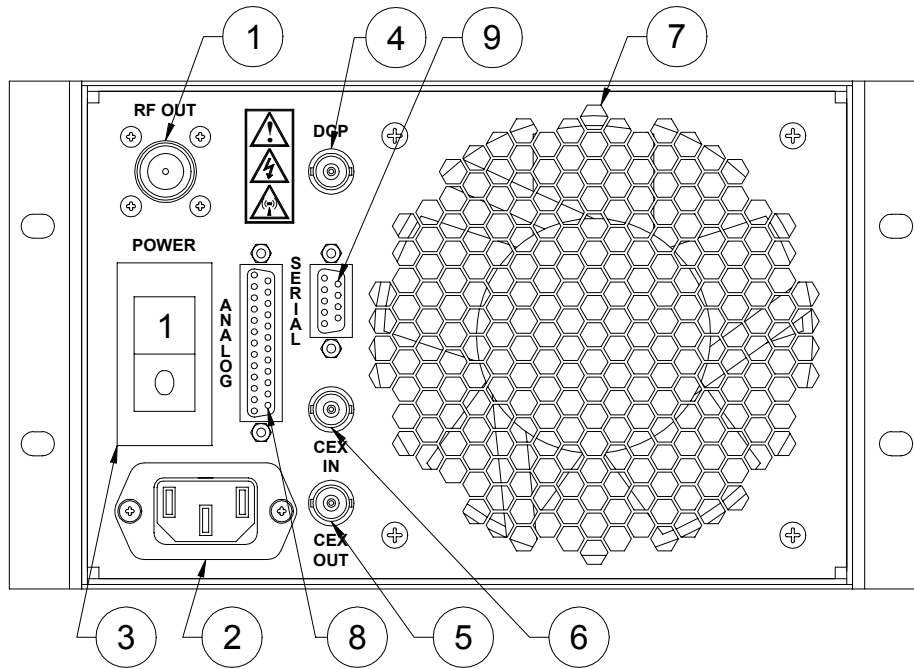

Models R601, L601, R1001, L1001

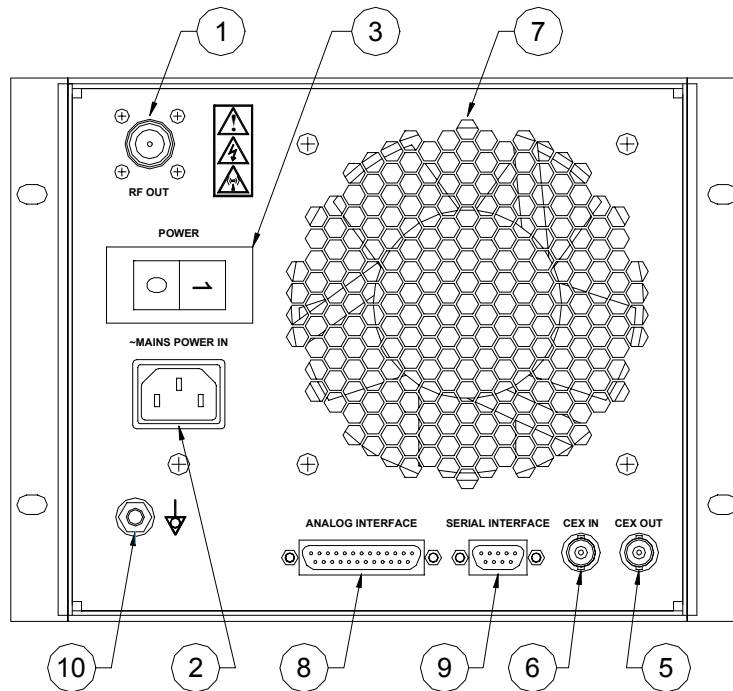

Model R1001W

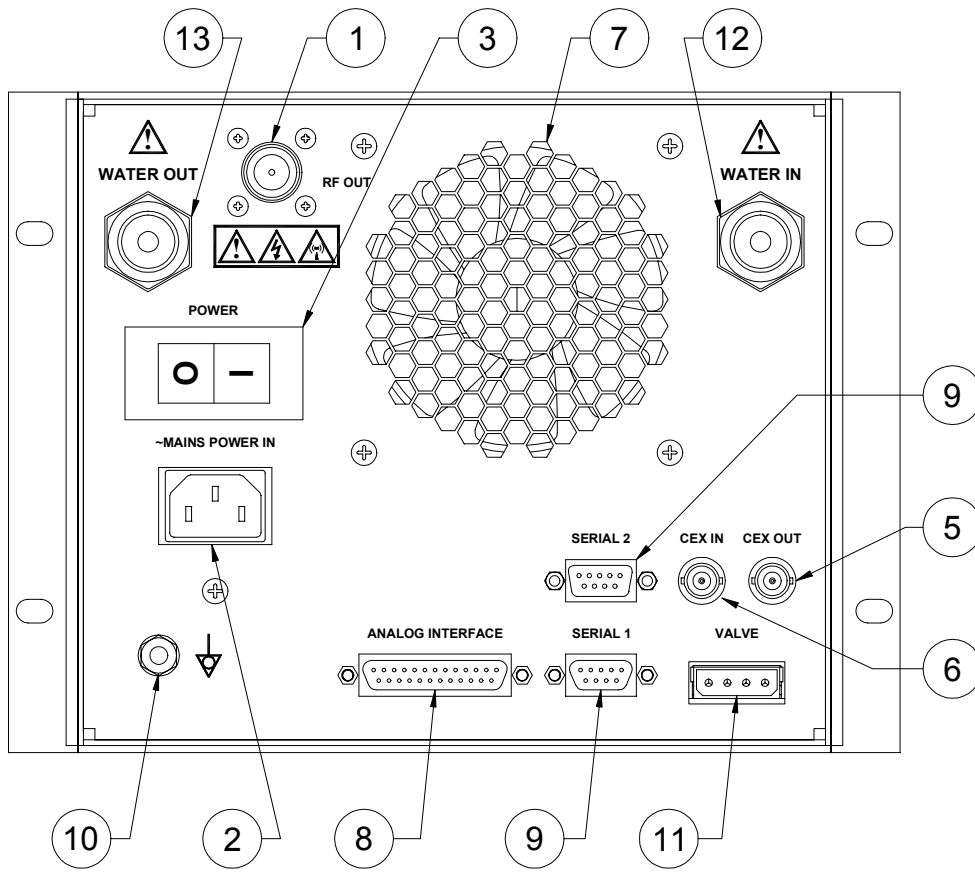

Models R2001, R2001H, L2001, L2001H, R3001, L3001

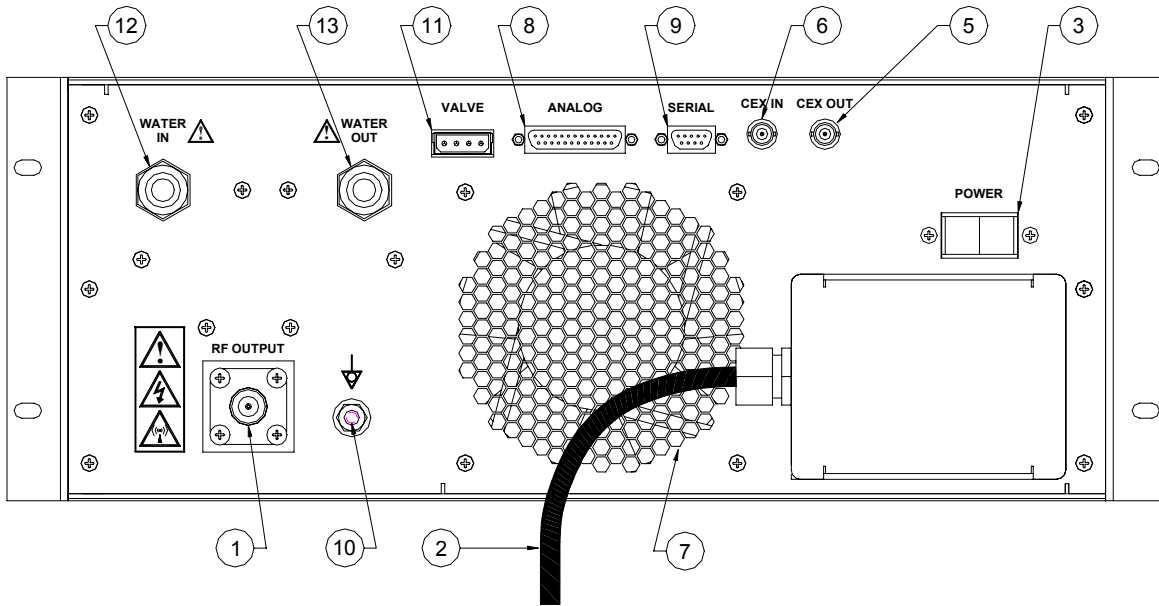

Model R5001

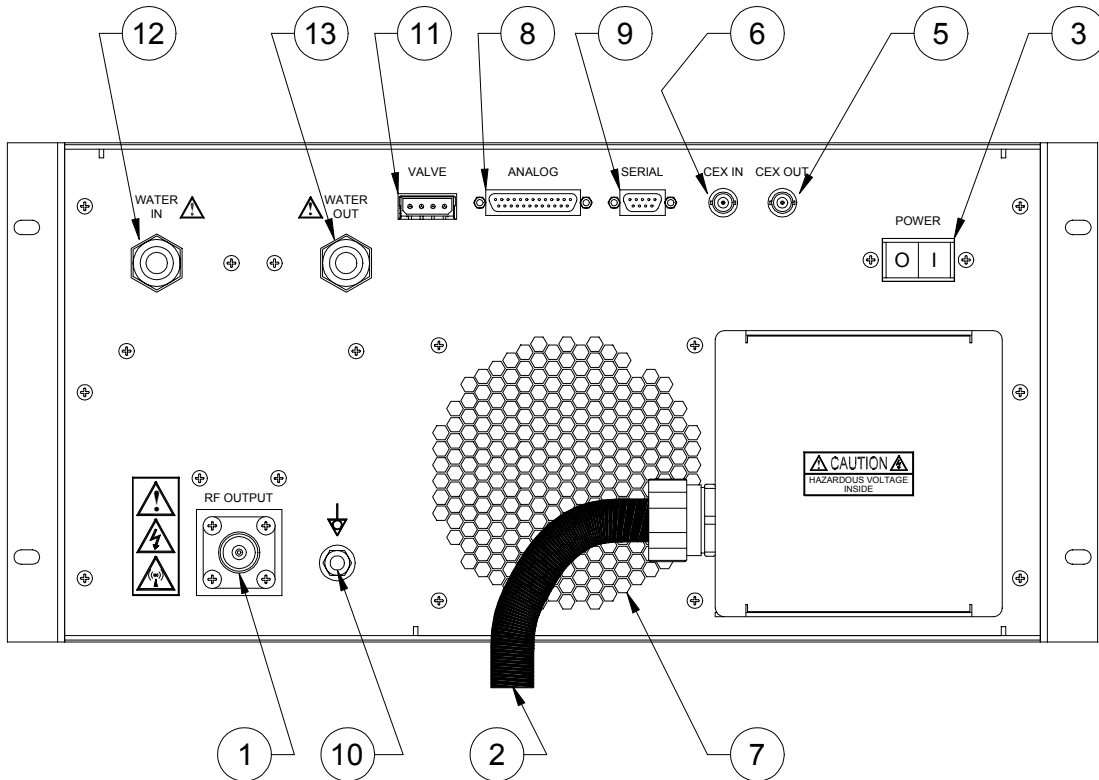

1. RF Output

Connect a 50-Ohm coaxial cable from the RF Output connector to a 50-Ohm load (50-Ohm resistive load, impedance matching network, impedance matching transformer, plasma chamber, or other processing apparatus). The center pin of the connector is RF “hot”, the connector shell is RF return.

2. Power Inlet or Power Cord

Before connecting to AC Mains power, verify the AC Mains voltage marked on the ratings plate, located on the top or side panel of the RF Power Supply, is compatible with your AC Mains voltage. If the AC Mains voltage on the ratings plate is not compatible with your AC Mains voltage, contact a Seren IPS Inc. service depot for assistance.



CAUTION: CHECK YOUR MAINS VOLTAGE AND THE MAINS VOLTAGE SPECIFIED ON THE RATINGS PLATE OR CONSULT A QUALIFIED ELECTRICIAN BEFORE CONNECTING THE RF POWER SUPPLY TO MAINS POWER. CONNECTING TO THE WRONG MAINS VOLTAGE MAY DAMAGE THE RF POWER SUPPLY AND VOID THE WARRANTY.

Power Inlet:

RF Power supply Models R/L101, R/L301, R/L101MKII, R/L301MKII, R/L601, R/L1001 are supplied with a rear panel power inlet and a detachable power cord. The cord type and Mains power plug are configured for the mains voltage specified at time of order.

Power Inlet Connector: IEC320 type male, filtered.

Mating Cord Connector: IEC320-C13.

Connect the supplied power cord to the power inlet and connect to mains power.



If the power cord is lost or damaged, replacement cords are available from Seren IPS Inc. or can be purchased locally. When purchasing a power cord from a local vendor, ensure the replacement cord is of the same wire gauge, current handling capacity, and voltage rating.

Captive Power Cord:

RF Power Supply Models R2001, L2001, R3001, L3001, R5001, and L5001 are supplied with captive power cords with locking power plugs. The power cord and power plug type are configured for the mains voltage specified at time of order.

3. Mains Circuit Breaker:

Set to the “1” position to enable, set to the “0” position to disable. To reset the circuit breaker, set the handle to the “0” position, then to the “1” position

4. DCP Connector (*Optional, Models R/L101,R/L301,R/L101MKII,R/L301MKII only*)

Voltage Probe Inverter Input. Analog input, 0 to –10VDC input range.

Connector: Type BNC Female

Input Impedance: 100K Ohm

Optional. Allows the RF Power Supply to use a negative polarity voltage probe signal from a passive probe (usually located in an external matching transformer or matching network) for external RF output regulation feedback (voltage control).

For RF Power Supplies with software version 9.0J2 and earlier:

Connect the negative polarity probe signal to the DCP connector. Connect Analog Interface connector pin 25 (INVPROBE output) to Analog Interface connector pin 24 (FEEDBACK input).

For RF Power Supplies with software version 9.0J3 and later:

Connect the negative polarity probe signal to the DCP connector and select inverted probe (VLT CNTRL –PRB BNC) from the programming menu

Note: Beginning with software version 9.0J3, a programming menu-controlled internal switch was added to route the probe inverter's output to the FEEDBACK signal. Refer to the Typical Interface Connections section for wiring details

5. CEX OUT Connector

Common EXciter output: 5 to 8V Peak-to-Peak, at specified operating frequency.

Connector: Type BNC Female

In “Master” mode, the common exciter output signal is present at all times regardless of the RF output state. In “slave” mode, the common exciter output signal is present when there is a signal present at the CEX IN connector.

In “Master” mode, the common exciter output frequency is the same as the programmed frequency. In “Slave” mode, the common exciter output frequency is the same as the signal at the CEX IN connector.

6. CEX IN Connector

Common Exciter input: 3 to 8V Peak-to-Peak sine wave, at specified operating frequency.

Connector: Type BNC Female

When in Slave mode, the RF Power Supply uses the common exciter input as its frequency source.

7. Fan Exhaust

Keep fan exhaust free of obstructions, dust and dirt.



When the RF Power Supply is mounted in an enclosure or equipment rack, ensure there is an adequate air intake and hot air exhaust. Operating the RF Power Supply at elevated temperatures or reduced airflow for long periods of time may degrade its reliability and/or void the warranty.

8. Analog Interface Connector

The analog interface connector is located on the rear panel of the Radio Frequency Power Supply. Control and status signals for the RF Power Supply are available on this connector. See the table below for descriptions of the interface connector signals.

Connector type: 25-pin female "D" sub-miniature.



To prevent radio frequency interference and ensure proper operation of the RF power Supply, foil-shielded cable is strongly recommended for making interface connections between the RF Power supply and system or accessory equipment.

Interface cables for accessory products are available from Seren IPS Inc., authorized Seren IPS representatives, and service depots. For assistance with system interfacing, contact your system vendor, Seren IPS Customer Service, or a Seren IPS service representative.



GND, GNDI, FWDRET, REFRET, FBRET, RFENABLED RET, and SETRET signals must be referenced at the user's system or the unit will not operate properly.

The RF Power Supply responds to input from the Analog Interface when ANALOG control has been selected. The External Interlock (pins 2 and 15) signal is active regardless of the selected control method.

Asterisk (*) denotes an active-low signal

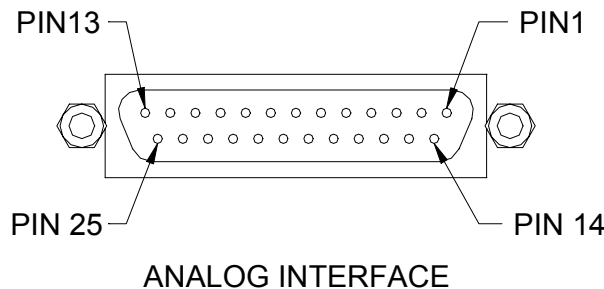

The RLX01 Series power supplies use a common Analog Interface connector, but some pin functions vary by model type. Where applicable, the variation in pin function has been noted.

ANALOG INTEFACE CONNECTOR PIN LIST		
PIN	SIGNAL NAME	DESCRIPTION
1	MAINS INTLK 1 R101, L101, R301, L301 only	<p>AC Mains Power Interlock. 24VAC current loop, 100 mA maximum current.</p> <p>A contact closure between pin 1 and pin 14 is required to allow AC mains power to engage. An open circuit between pin 1 and pin 14 disables AC mains power.</p> <p>This signal is active in Panel, Analog, or Serial control modes</p> <p>NOTE: Applicable to models R101, L101, R301, and L301 only.</p>
	PSYNC R101MKII, L101MKII, R301MKII L301MKII, R/L601, R/L1001, R/L2001, R/L3001, R5001	<p>Pulse Synchronization Output. TTL-compatible output, with an internal pull-up resistor.</p> <p>Outputs a pulse train from the internal pulse train generator when internal pulsing is selected and active.</p> <p>Outputs the pulse train from the Gate signal (pin 7) when external pulsing is selected.</p> <p>A TTL high state corresponds to RF output at SETPOINT level or "High Power Pulse" level, a TTL low state corresponds to 0 Watts or "Low Power Pulse" level. Refer to the pulsing parameters in the programmable parameters section for operational details.</p> <p>NOTE: Applicable to models R101MKII, L101MKII, R301MKII L301MKII, R/L601, R/L1001, R/L2001, R/L3001, and R5001</p>
2	INTERLOCK	<p>External Interlock. TTL – compatible input, active low, with an internal pull-up resistor.</p> <p>A contact closure between pin 2 and pin 15 or a TTL "low" signal applied to pin 2 is required before RF output can be enabled.</p> <p>An open circuit or a TTL "high" signal applied to pin 2 while the RF output is enabled, will cause the RF output to turn off.</p> <p>An open circuit or a TTL "high" signal applied to pin 2 while the RF output is off, will prevent the RF output from being enabled.</p> <p>This signal is active in Panel, Analog, or Serial control modes</p>
3	RFON*	<p>RF Output Enable/Disable. TTL – compatible input, active low, edge triggered, with an internal pull-up resistor.</p> <p>A contact closure between pin 3 and pin 16 or a TTL signal transition from "high" to "low" applied to pin 3 enables the RF output, provided Pin 2 is at TTL "low" state.</p> <p>An open circuit between pin 3 and pin 16 or a TTL signal transition from "low" to "high" applied to pin 3 disables the RF output.</p> <p>This signal is active only in "Analog" control mode.</p>

ANALOG INTEFACE CONNECTOR PIN LIST		
PIN	SIGNAL NAME	DESCRIPTION
4	PWR/VLT*	<p>Power or Voltage leveling mode select. TTL – compatible input with internal pull-up resistor.</p> <p>An open circuit or TTL “high” signal applied to pin 4 selects the power supply’s internal power sensor for power regulation.</p> <p>A contact closure between pin 4 and pin 16 or a TTL “low” signal applied to pin 4 selects forward power regulation based on an external feedback signal (FEEDBACK signal - Pin 12).</p> <p>Refer to the controls section of the operator’s manual for detailed instructions on how to configure and use this mode.</p> <p>This signal is active only in “Analog” control mode.</p>
5	SLAVE*	<p>Selects internal oscillator/exciter or external oscillator/exciter (Slave Mode) as frequency source operation. TTL – compatible input with an internal pull-up resistor.</p> <p>A contact closure between pin 5 and pin 17 or applying a TTL “low” signal to pin 5 selects external frequency source (Slave Mode) operation. The external frequency source is connected to the “CEX IN” connector on the rear panel.</p> <p>An open circuit or TTL “high” applied to pin 5 selects the power supply’s internal oscillator/exciter as the frequency source.</p> <p>This signal is active only in “Analog” control mode.</p>
6	GATEN*	<p>Selects Continuous Wave (CW) or Pulse Operation. TTL – compatible input with an internal pull-up resistor.</p> <p>A contact closure between pin 6 and pin 17 or applying a TTL “low” signal to pin 6 selects pulse operation. Apply the external pulse train to Pin 7.</p> <p>Applying a logic level high to this pin or allowing this pin to float selects continuous wave (CW) operation.</p>
7	GATE	<p>External Pulse Train input. Toggles output power between setpoint value and 0 Watts. TTL - compatible input with internal pull-up resistor.</p> <p>An open circuit or TTL “high” signal applied to pin 7 holds the RF output to the setpoint level.</p> <p>A contact closure between pin 7 and pin 17 or a TTL ‘low’ signal applied to pin 7 switches the RF output power to 0 Watts.</p> <p>Active when pin 6 (GATEN*) is in a TTL “low” state.</p>
8	RFENABLED*	<p>RF output status signal. Active low, open collector output. 24VDC, 15mA maximum current sink, 150mW maximum power dissipation.</p> <p>Signal output is 0V (low) for an RF on condition; signal output is “open” for an RF off condition.</p> <p>The RFENABLED* signal can also indicate the presence of</p>

ANALOG INTEFACE CONNECTOR PIN LIST		
PIN	SIGNAL NAME	DESCRIPTION
		<p>excessive reflected power by changing from a “low” state to a “high” state when the RF output is enabled. Refer to “Reflected Power Alarm ON/OFF” and “Reflected Alarm Threshold” in the Programmable Parameters section for details.</p> <p>The RFENABLED* output signal may also be used to pre-position Seren IPS Inc. AT-Series Matching Networks. Refer to “Matching Network Preset Mode”, “Tune Capacitor Preset Position”, and “Load Capacitor Preset Position” in the Programmable Parameters section. Requires +5VDC pull-up enabled.</p> <p>NOTE: For units manufactured on or before July 30, 2005, this pin is internally pulled up to +5VDC. For unit manufactured on August 1, 2005 and later, this pin may be configured as internally pulled up to +5VDC (factory default configuration) or without a +5VDC pull-up. (OEM custom configurations). Configuration is set at the factory. Use pin 18 for a reference return.</p>
9	GND	Internally connected to chassis ground. Connect to system controller common or ground reference.
10	FWD MON	<p>Forward power monitor output signal. Analog output, selectable 0 to +5VDC or 0 to +10VDC range via front panel controls.</p> <p>Output is linearly proportional to 0 to 100% of rated forward power.</p> <p>Refer to the Power Monitor Scaling subsection in the appropriate model specification for forward power monitor scaling details.</p> <p>The forward power monitor output signal may also be used to pre-position Seren IPS Inc. AT-Series Matching Networks. Refer to “Matching Network Preset Mode”, “Tune Capacitor Preset Position”, and “Load Capacitor Preset Position” in the Programmable Parameters section.</p> <p>Measure monitor voltage with respect to pin 22 (FWDRET).</p>
11	REFP MON	<p>Reflected power monitor output signal. Analog output, selectable 0 to +5VDC or 0 to +10VDC range via front panel controls.</p> <p>Refer to the Power Monitor Scaling subsection in the appropriate model specification for reflected power monitor scaling details.</p> <p>The reflected power monitor output signal may also be used to pre-position Seren IPS Inc. AT-Series Matching Networks. Refer to “Matching Network Preset Mode”, “Tune Capacitor Preset Position”, and “Load Capacitor Preset Position” in the Programmable Parameters section.</p> <p>Measure monitor voltage with respect to pin 23 (REFRET).</p>

ANALOG INTEFACE CONNECTOR PIN LIST		
PIN	SIGNAL NAME	DESCRIPTION
12	FEEDBACK	<p>External feedback voltage signal. Analog input, 0 to +10.0VDC . Use pin 16 or 17 or (GNDI) for return reference.</p> <p>The RF Power Supply will automatically adjust its output power to maintain the FEEDBACK signal's magnitude at the same level as the SETPOINT signal magnitude. The PROBE voltage will be displayed on the front panel. The PROBE attenuation factor can be configured from the front panel.</p> <p>The external feedback signal is derived from a voltage probe (RF or DC) located elsewhere in the plasma or process system. Refer to the controls section for detailed instructions on how to configure and use this mode.</p> <p>Note: The feedback voltage polarity must match the setpoint input's (pin 13) polarity for proper operation of voltage control mode. The RF Power Supply's external feedback circuitry is not designed to function with Negative (-) polarity signals applied to this pin.</p>
13	SETPOINT	<p>Power or Voltage setpoint input. Analog, high-impedance, differential input with selectable 0 to +5.0VDC or 0 to +10.0VDC range via front panel controls.</p> <p>Refer to the controls section of the operator's manual for detailed instructions on how to configure and use this mode</p> <p>NOTE: SETRET (pin 25) MUST be referenced to common or ground at the setpoint voltage source (system controller) or the RF output power will behave erratically.</p> <p>Refer to the Analog Setpoint Sensitivity subsection of the appropriate model specification for setpoint sensitivity details.</p> <p>NOTE: Feedback voltage range and polarity must match setpoint voltage range and polarity for proper operation in voltage control mode.</p> <p>Pin 13 is the positive (+) input of the differential setpoint amplifier.</p> <p>Active only in ANALOG control mode.</p>
14	MAINS INTLK 2 R101, L101, R301, L301 only	<p>A contact closure between pin 1 and pin 14 is required to allow AC mains power to engage. An open circuit between pin 1 and pin 14 disables AC mains power. 24VAC current loop, 100 mA maximum current</p> <p>This signal is active in Panel, Analog, or Serial control modes</p> <p>NOTE: Applicable to models R101, L101, R301, L301 only.</p>
	No Connection R101MKII, L101MKII, R301MKII, L301MKII, R101, L101, R301, L301	<p>No Connection</p> <p>Note: Applicable to models R101MKII, L101MKII, R301MKII,</p>

ANALOG INTEFACE CONNECTOR PIN LIST		
PIN	SIGNAL NAME	DESCRIPTION
	L301MKII, R/L601, R/L1001, R/L2001, R/L3001, R5001	L301MKII, R/L601, R/L1001, R/L2001, R/L3001, and R5001
15	INTERLOCK-RTN	Ground return for External Interlock (pin 2)
16	GNDI	Ground return for pins 3,4,5,6,7,19. Internally connected to chassis ground. Connect to system controller common or ground reference
17	GNDI	Ground return for pins 3,4,5,6,7,19. Internally connected to chassis ground. Connect to system controller common or ground reference
18	RFENABLED RET	Ground return for pin 8 (RFENABLED* signal). For units manufactured on or before July 30, 2005, this pin is internally connected to chassis ground (GNDI). For unit manufactured on August 1, 2005 and later, this pin may be configured as internally connected to chassis ground (GNDI) (factory default configuration) or isolated from chassis ground (OEM custom configurations). Configuration is set at the factory. Connect to system controller common or ground reference.
19	RL-IN	Remote Limit input. Analog input, 0 to +5VDC range. Use pin 16 or 17 (GNDI) for return reference. Used in dual-bias or multiple power supply systems to fold-back the power supply's output power if reflected power is detected by another power supply in the system. Output power folds back in response to an external voltage applied to this input. Foldback threshold is factory preset at +5.00VDC (Disabled). Consult factory for assistance.
20	RL-OUT	Remote Limit Output. Analog output, 0 to +10VDC range. Buffered, high-speed, non-linearized directional coupler reflected power signal. Return reference is pin 23. Used on dual-bias or multiple power supply systems. Consult factory for assistance.
21	PHASE	External Phase Sensor Input. Analog Input, -10.0VDC to +10.0VDC range. Used in conjunction with the Variable Frequency Tuning (VFT) feature. On VFT-enabled units with VFT Feedback Mode set to "PHASE TUNE MODE +" or "PHASE TUNE MODE -" the voltage signal from an external phase detector is used to steer

ANALOG INTEFACE CONNECTOR PIN LIST		
PIN	SIGNAL NAME	DESCRIPTION
		<p>the RF output's frequency.</p> <p>The external phase detector's output is applied to the PHASE input signal. When the PHASE signal is 0.00VDC, the RF Power Supply assumes reflected power is at minimum and stops the tuning process.</p>
22	FWDRET	Forward Power Monitor return. Analog output. For pin 10.
23	REFRET	Return reference for Reflected Power Monitor and Remote Limit output signals. Analog output. For pins 11 and 20.
24	No Connection	<p>No Connection</p> <p>NOTE: Applicable to: Models R101MKII, L101MKII, R301MKII L301MKII with software version 9.0J3 or greater, <i>with or without</i> rear panel "DCP" connector installed. Models R101, L101, R301, L301 <i>without</i> rear panel "DCP" connector installed. Models R/L601, R/L1001, R/L2001, R/L3001, and R5001</p>
	<p>FEEDBACK R101, L101 R301, L301 R101MKII, L101MKII, R301MKII L301MKII Models only</p>	<p>Note: This pin function is not supported on units with software version 9.0J3 or greater because the user can route the inverted probe signal to pin 12 via a selection in the programming menu.</p> <p>External feedback voltage signal. Analog input, 0 to +10.0VDC. Internally connected to pin 12. Use pin 16 or 17 (GNDI) for return reference.</p> <p>The RF Power Supply will automatically adjust its output power to maintain the FEEDBACK signal's magnitude at the same level as the SETPOINT signal magnitude. The PROBE voltage will be displayed on the front panel. The PROBE attenuation factor can be configured from the front panel.</p> <p>The external feedback signal is derived from a voltage probe (RF or DC) located elsewhere in the plasma or process system. Refer to the controls section for detailed instructions on how to configure and use this mode.</p> <p>Note: The feedback voltage polarity must match the setpoint input's (pin 13) polarity for proper operation of voltage control mode.</p> <p>Note: Applicable <i>only</i> to models R101, L101, R301, L301, R301MKII, L301MKII with software version 9.0J2 or less, with optional "DCP" connector installed on the rear panel.</p>

ANALOG INTEFACE CONNECTOR PIN LIST		
PIN	SIGNAL NAME	DESCRIPTION
25	SETRET	<p>Setpoint Return. Analog differential input (-). Note: This pin <i>must</i> be connected to a ground reference or the unit's output will behave erratically</p> <p>NOTE: Applicable to: Models R101MKII, L101MKII, R301MKII, and L301MKII with software version 9.0J3 or greater, <i>with or without</i> rear panel "DCP" connector installed. Models R101, L101, R301, L301 <i>without</i> rear panel "DCP" connector installed. Models R/L601, R/L1001, R/L2001, R/L3001, and R5001</p>
	INVPROBE R101, L101 R301, L301 R101MKII, L101MKII, R301MKII L301MKII Models only	<p>Note: This pin function is not supported on units with software version 9.0J3 or greater because the user can route the inverted probe signal to pin 12 via a selection in the programming menu.</p> <p>Inverted Probe Output. Analog output, 0 to +10.0VDC. Inverted polarity signal derived from the optional rear panel "DCP" BNC connector. Magnitude of the signal remains identical, polarity changed from negative (at the PROBE connector) to positive. Connect to pin 24 (if required) when using external feedback to regulate RF output level.</p> <p>Note: Applicable <i>only</i> to models R101, L101, R301, L301, R301MKII, L301MKII with software version 9.0J2 or less, with optional "DCP" connector installed on the rear panel.</p>

TYPICAL INTERFACE CIRCUITS

Figures 1 through 5 illustrate the typical circuits used in the RF Power Supply's Analog Interface.

Note: GND, GNDI, and SETRET signals must be referenced to system common or system ground to avoid erratic power supply operation.

RFENABLED* Output Circuit:

RF output status signal. Signal output is closed (0V or "low") for an RF ON condition; signal output is "open" for an RF OFF condition or Reflected Power Alarm condition. The reflected power alarm indication can be disabled. Refer to the Programming Menu "Reflected Alarm ON/OFF" and "Reflected Alarm Threshold" parameters and the Analog Interface Pin List table for operational details.

Default Configuration: Active low, open collector output with +5VDC pull-up.
(No pull-up and isolated configurations are possible, consult factory for details)

Signal Rating: 24VDC maximum (with pull-up disabled), 15mA maximum current sink, 150mW maximum power dissipation.

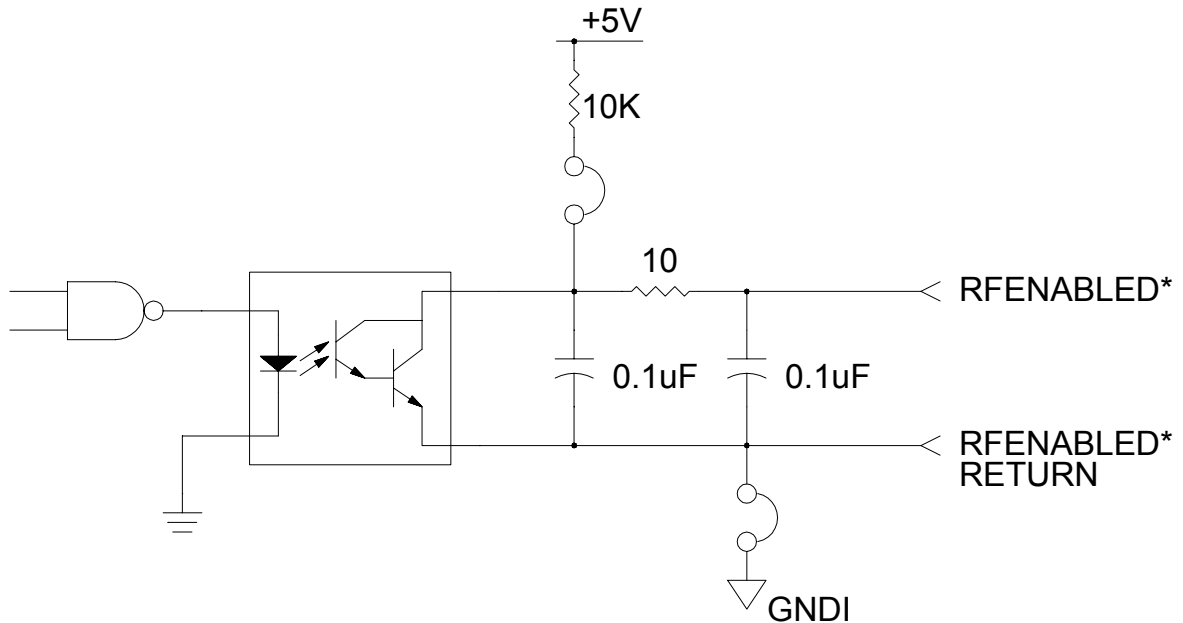

Figure 1: RFENABLED* Circuit

TTL-Compatible Input Circuits

All TTL-Compatible logic input circuits are internally pulled up to +5VDC. Signal function and response is as described in the Analog Interface Connector pin list.

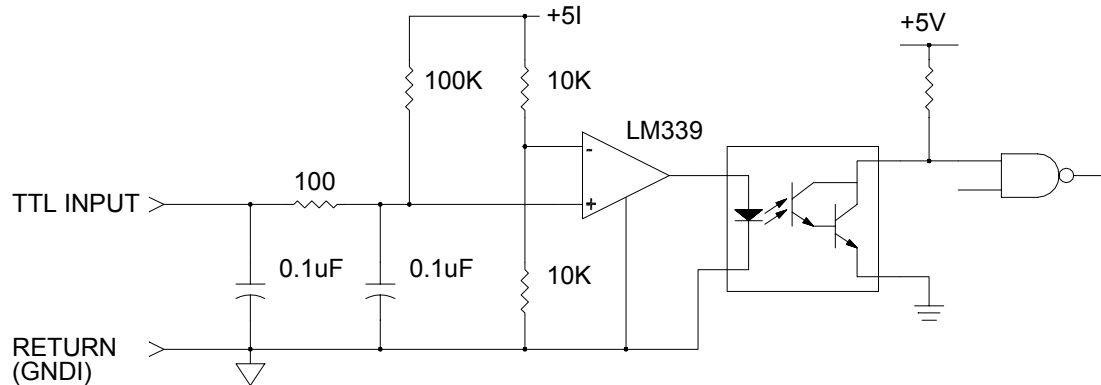

Figure 2: TTL-Compatible Input Circuits

SETPOINT Input Circuit

High-impedance, high Common-Mode Rejection Ratio, differential analog input. Input voltage range is software selectable 0 to +5.0VDC or 0 to +10.0VDC via the front panel controls. NOTE: The setpoint return signal (SETRET, pin 25) **MUST** be referenced to common or ground at the setpoint voltage source (system controller) or the RF output power will behave erratically.

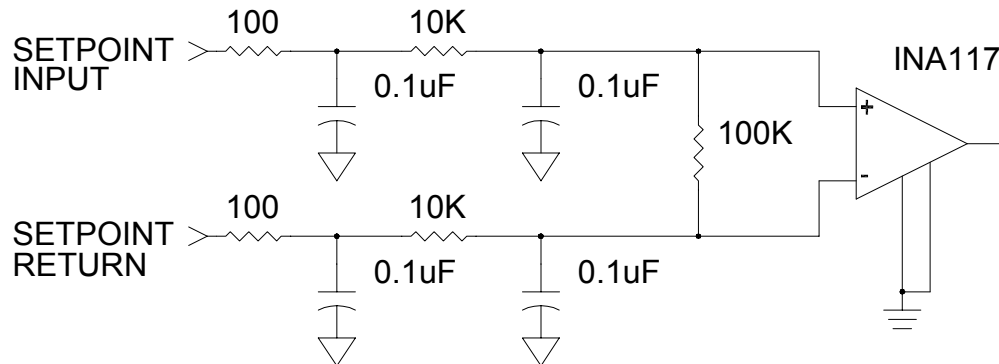

Figure 3: SETPOINT Input Circuit

FEEDBACK Input Circuit

High-impedance, high Common-Mode Rejection Ratio, analog input. Input voltage range is 0 to +10.0VDC. NOTE: The feedback return signal (GNDI, pin 16 or 17) MUST be referenced to common or ground at the feedback voltage source (Voltage Probe) or the RF output power will behave erratically.

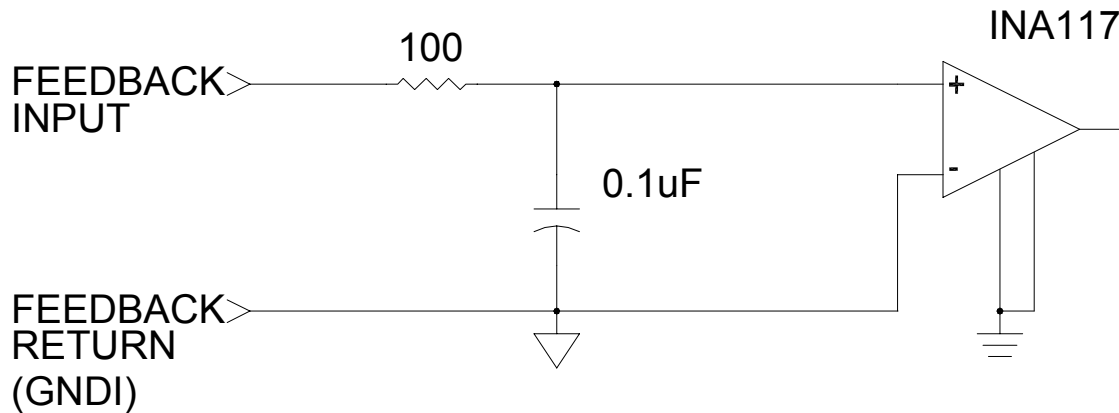

Figure 4: FEEDBACK Input Circuit

MONITOR Output Circuit

Analog output, selectable 0 to +5VDC or 0 to +10VDC range via front panel controls. Normal function is forward or reflected power monitoring, but can be configured to pre-position Seren IPS Inc. AT-Series Matching Networks. See the Programming Menu reference for additional details.

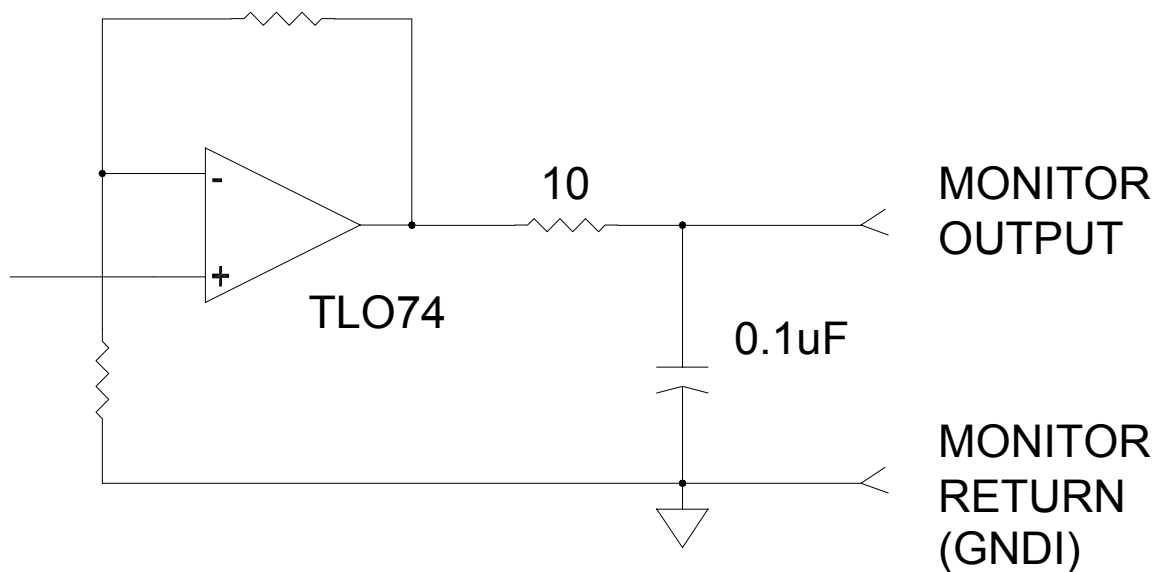

Figure 5: MONITOR Output Circuit

9. Serial Interface Connector

The serial interface provides remote control and monitoring of the RF Power Supply via a computer. Serial interface protocols are selectable, RS-232, RS-422, and RS-485. Baud rates and protocols are selected via the front panel.

Connector Type: 9 pin "D" female

For serial operation details, see the Serial Commands section of this manual.

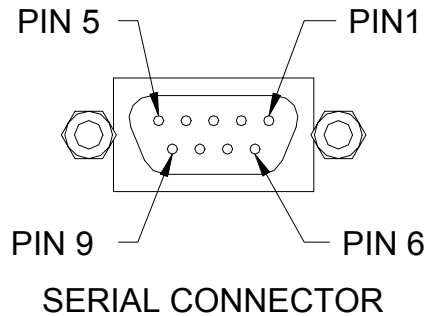

Note: To accommodate multi-protocol operation, Seren RF Power Supplies use a non-standard serial interface connector pin assignment.

SERIAL INTERFACE CONNECTOR PIN LIST		
Pin	Signal	Description
1	No Connection	No Connection
2	TXB-232	RS-232 Transmit Data (Internally connected to pin 4)
3	RXB-232	RS-232 Receive Data
4	TXB-232	RS-232 Transmit Data (Internally connected to pin 2)
5	+RCV	RS-422/485-4 +RCV
6	-RCV	RS-422/485-4 -RCV
7	+XMIT	RS-422/485-4 +XMIT (RS-485-2 RCV/XMIT)
8	-XMIT	RS-422/485-4 -XMIT (RS-485-2 RCV/XMIT)
9	Common	Common

Serial Interface Wiring

Seren IPS strongly recommends the use of shielded cable when making serial interface connections. The use of unshielded cable may result in data errors and other serial communication problems.

Typical RS-232 serial interface wiring is diagrammed below. RS-422 and RS-485 wiring methods are not shown because not all hardware manufacturers implement the recommended connector pin-outs for RS-422/RS-485. Consult the documentation provided with your RS-422/RS-485 serial interface hardware and the Serial Interface Connector Pin List to determine the proper wiring method for your hardware.

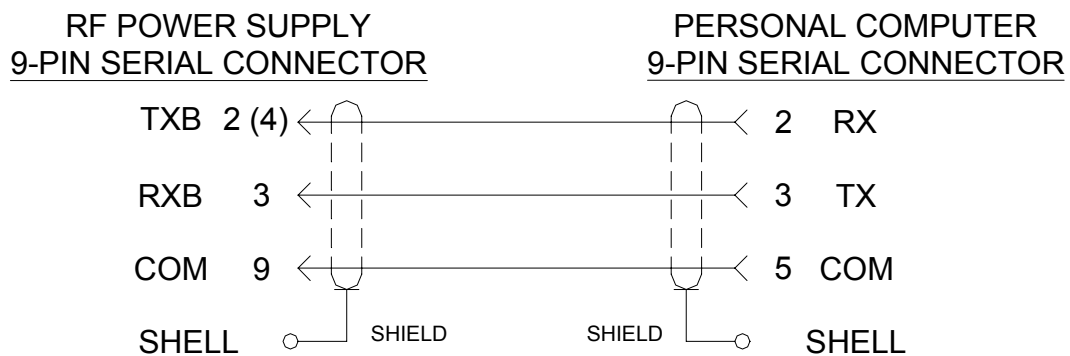

RS-232 Serial Interface Wiring

Seren RF Power Supply to Personal Computer 9-pin Serial Connector

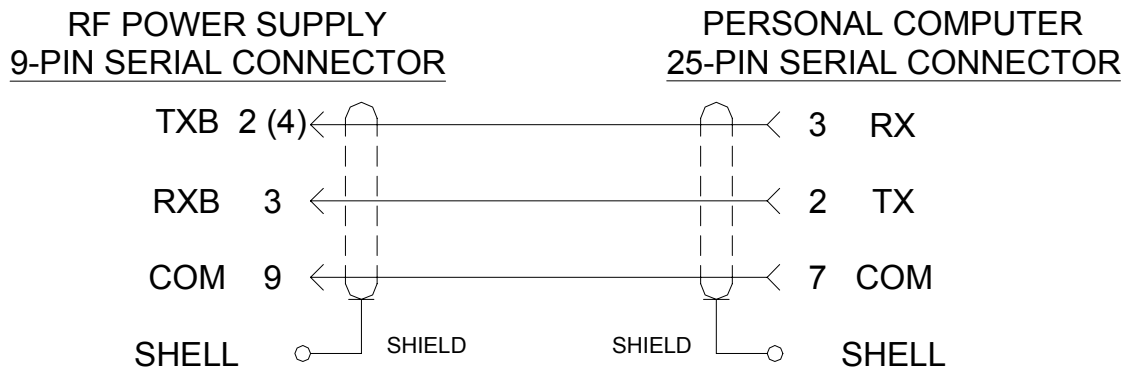

RS-232 Serial Interface Wiring

Seren RF Power Supply to Personal Computer 25-pin Serial Connector

10. Equipotential Bonding Terminal



A metal stud is pressed directly into the rear panel, supplied with mating nut and washers. Connect equipotential bonding straps from system equipment and/or an earth ground to this stud to control RF circulating currents. Stud type is listed by model in the table below.



Equipotential bonding (often referred to as grounding) is used to control RF circulating currents within a system. For regulatory purposes, it is not a “Protective Earth” or “Safety Ground”, even though it may be bonded to the “Protective Earth” or “Safety Ground” within the equipment or user’s facility.

Model Type	Stud Type
R/L101, R/L301, R/L101MKII, R/L301MKII	None
R/L601, R/L1001	10-32 x 3/4”, supplied with flat washer and locking hex nut
R/L2001, R/L3001, R/L5001	1/4-20 x 3/4”, supplied with flat washer and locking hex nut

Connect the equipotential bonding strap to the system equipment’s frame or bonding point with 0.01” thick, 2” wide copper strap. Keep equipotential bonding straps as short as possible.

11. Valve Connector (*Water Cooled Models Only*)

Connect the external solenoid water valve to the VALVE connector. To prevent condensation inside the R3001, the solenoid water valve disables water flow when the RF Output is “off” or when AC mains power is disabled. The valve connector pin-list is diagrammed below:

Connector Type:	4-pin male disk drive connector
Mating Connector (supplied on water valve assembly)	Housing: Molex Inc. 15-24-4048 Terminal: Molex Inc. 02-08-1202

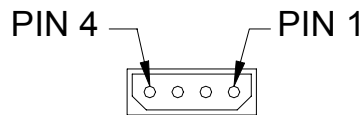

VALVE CONNECTOR

Valve Connector Pin List		
PIN	SIGNAL NAME	DESCRIPTION
1	PUP	+5VDC current-limited pull-up for water valve interlock.
2	VALVE +	+44VDC, Current limited to 1.0A (by internal re-settable fuse)
3	VALVE -	Open collector transistor output. Connects to chassis ground to enable valve. 1.0A maximum current. 50VDC maximum voltage
4	WATERINT	Optional Water Valve Interlock. Custom software option, factory configured. Standard software ignores this signal. TTL compatible logic input, active high. Apply a TTL logic high signal or connect to pin 1 to complete water valve interlock. An open circuit or TTL logic low applied to this pin will prevent the RF output from being enabled or, will disable the RF output if the RF output is enabled.

12. Coolant Water IN Port (*Water Cooled Models Only*)

Fitting Type: 3/8" N.P.T. (tapered) dry-seal, hexagonal female pipe.

Connect the output port of the solenoid water valve to the WATER IN port. Connect the coolant water supply to the input port of solenoid water valve.



Important Note: Install or remove the solenoid water valve in accordance with the water fitting installation or removal methods outlined in the Installation section.

Improper installation, removal, or over-tightening of water fittings will damage the water inlet/outlet ports and cause water leaks. The water leak may be internal and unobserved.

Damage to the water inlet/outlet ports and internal components resulting from improper fitting installation or removal are not covered by Seren IPS Inc. product warranty.

13. Coolant Water OUT Port (*Water Cooled Models Only*)

Fitting Type: 3/8" N.P.T. (tapered) dry-seal, hexagonal female pipe.

Connect the coolant water return to the WATER OUT port.



Important Note: Install or remove fittings in accordance with the water fitting installation or removal methods outlined in the Installation section.

Improper installation, removal, or over-tightening of water fittings will damage the water inlet/outlet ports and cause water leaks. The water leak may be internal and unobserved.

Damage to the water inlet/outlet ports and internal components resulting from improper fitting installation or removal are not covered by Seren IPS Inc. product warranty.

TYPICAL ANALOG INTERFACE CONNECTIONS

Analog Control

There are many possible analog interface wiring schemes. Basic analog interface connections are diagrammed below. Refer to the Analog Interface Connector pin list in the Rear Panel Controls and Connections section for signal details. Use shielded cable for all interconnections.

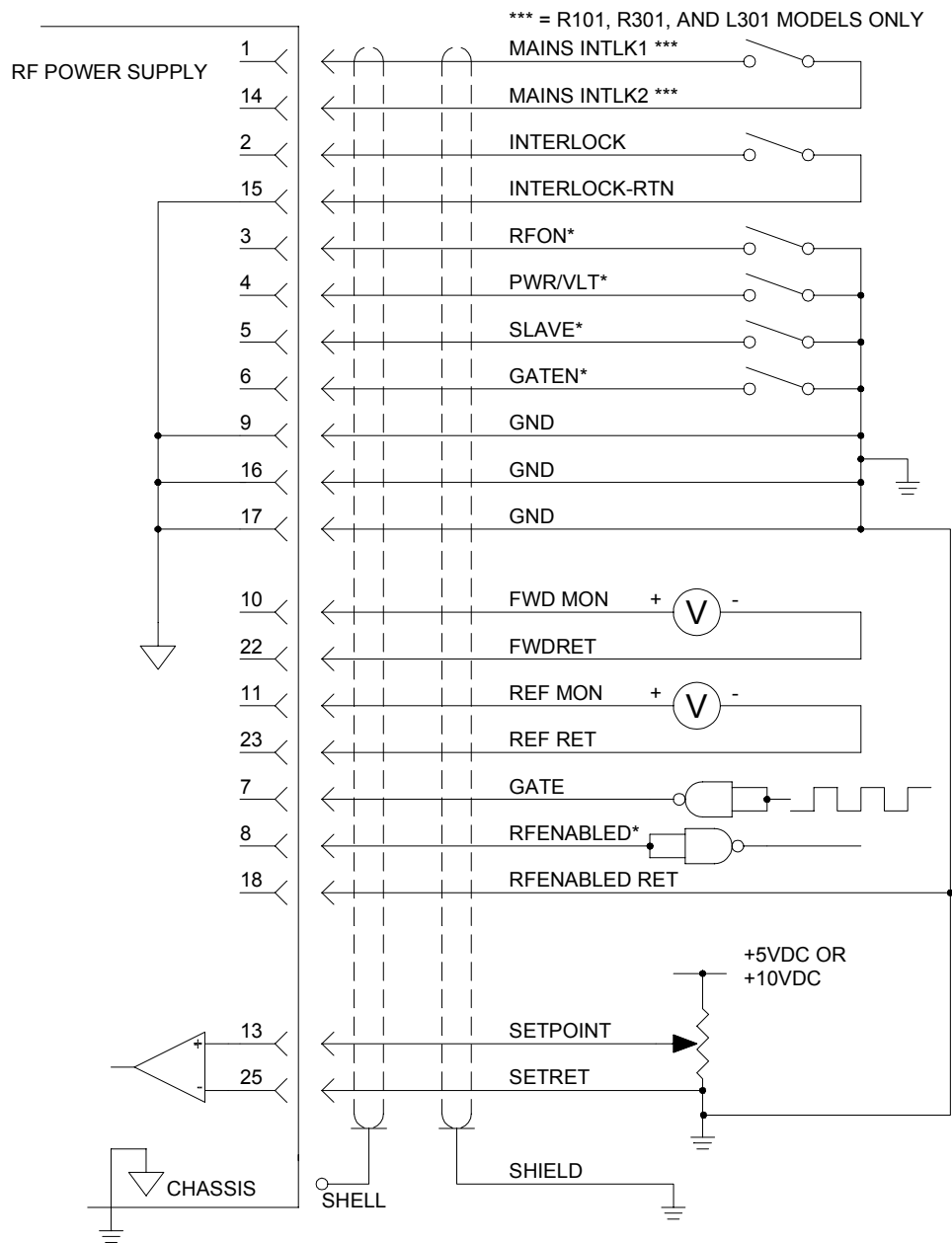

Typical Analog Interface Connections

External Feedback with Probe Inverter Option

The RF power supply's external feedback input (FEEDBACK, analog interface connector pin 12) only accepts a positive (+) polarity signal. The Probe Inverter feature allows the R101, R101MKII, R301, R301MKII, L031, and L301MKII RF Power Supplies to utilize a negative polarity feedback signal.

For units with software version 9.0J2 or earlier, Connect the negative polarity external feedback signal to the rear panel "DCP" BNC connector and connect Analog Interface connector pin 24 to pin 25.

For units with software version 9.0J3 or later, Connect the negative polarity external feedback signal to the rear panel "DCP" BNC connector and select inverted probe from the programming menu (VLT CNTRL -PRB BNC)

Note: Beginning with software version 9.0J3, a programming menu-controlled internal switch was added to route the probe inverter's output to the FEEDBACK signal.

If desired, the inverted probe signal may also be routed to the user's system for monitoring purposes. Use analog interface connector pins 12 (FEEDBACK) and 16 (GNDI). Connections **must** be made with shielded cable to prevent interference to the feedback signal.

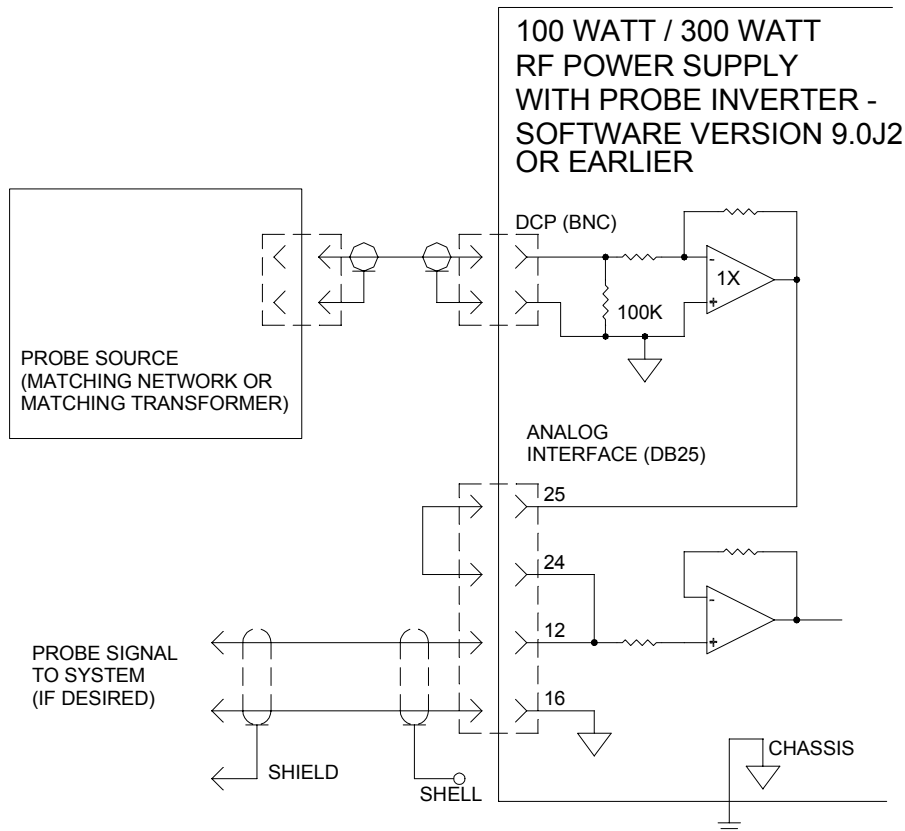

Probe Inverter Connections
Software version 9.0J2 and Earlier

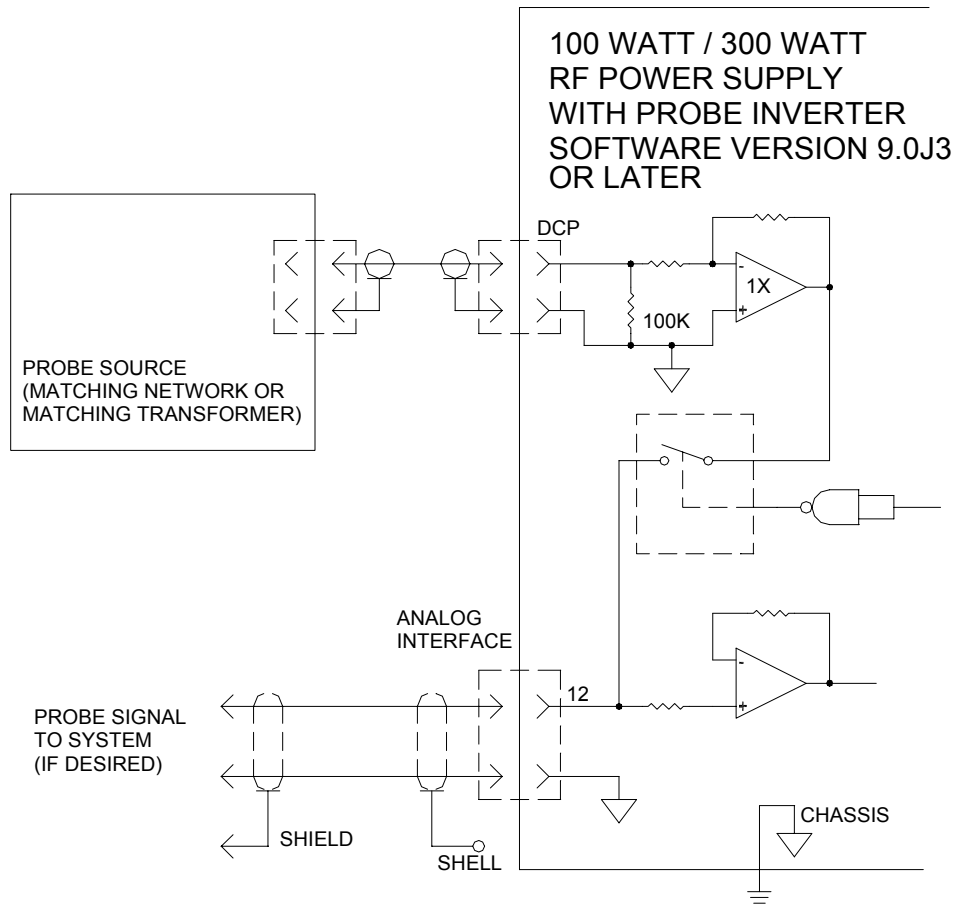

Probe Inverter Connections
Software version 9.0J3 and Later

Typical System Configuration

A basic plasma processing system configuration is diagrammed below. Other system configurations are possible. For assistance with system configuration issues, contact the Seren IPS Inc. customer service department or a Seren IPS Inc. service depot. Coaxial cables, control cables, matching networks, matching network controllers, and plasma system equipment are not supplied with the RF Power Supply.

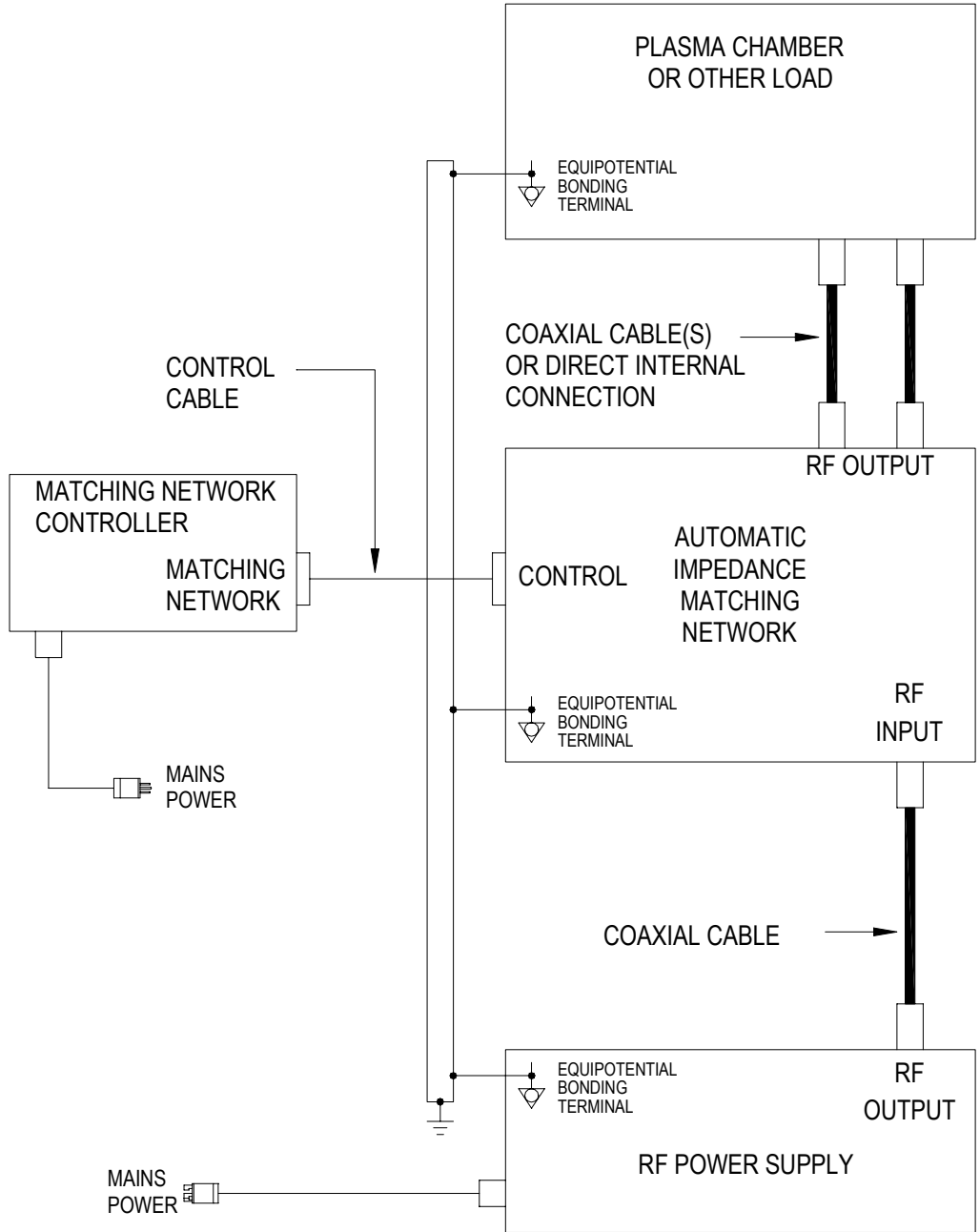

Typical Configuration - Basic Plasma Processing System

Maintenance

Seren IPS Inc R/LX01 Series Radio Frequency Power Supplies are designed to be maintenance free. There are no user maintainable assemblies inside the unit. The R/LX01 series RF Power Supplies are designed for use in a clean environment. Periodically check the air inlets and exhaust fan vents for accumulation of dust and debris. Clean the air inlets and exhaust fan with a vacuum cleaner if they appear dirty or clogged.



Restricting the air inlets, blocking the exhaust fan, or installing the RF Power Supply in a dusty environment may impact the long-term reliability of the RF Power Supply.

Cleaning:

DO NOT clean the RF Power Supply when AC Mains power is applied to the unit or when the unit is connected to the AC mains. The exterior of the RF power supply may be cleaned with a soft cloth, dampened with soap and water or a mild solvent, such as alcohol. Allow time for the RF power supply to dry before re-connecting to AC Mains power.

Problem Solving

Problem Solving Chart

The following chart lists some conditions that may occur and the recommended solutions. Follow the suggested solutions until the problem is corrected. If the problem persists, please contact Seren IPS Inc. customer service or a Seren IPS Inc. service representative.

Condition	Suggested Solution
Front panel display does not illuminate	<p>Check the power connector – ensure it is properly seated in the AC Mains power inlet.</p> <p>Verify rear panel circuit breaker is in the “1” (on) position.</p> <p>Ensure the Analog Interface Connector is fully seated.</p> <p>Models R101, L101, R301, L301: ensure the Analog Interface “MAINS INTLK” circuit is completed – connect pin 1 to pin 14 on the analog interface connector.</p> <p>Verify the front panel power switch is in the “1” (on) position (depressed).</p>
Cannot enable the RF output by pressing the front panel RF ON/OFF button	<p>Ensure the Analog Interface Connector is fully seated and the Analog Interface “INTERLOCK” signal is at a TTL “low” state – apply a TTL “low” signal to pin 2 of the Analog Interface Connector or connect pins 2 and 15 together on Analog Interface Connector.</p> <p>Verify the unit is in “Panel” control mode – check the front panel display, line 2, left-hand side. “PANEL” should be displayed. For information on changing control mode, refer to the “Control Source” heading in the Operation section.</p>
Cannot enable the RF output by pressing the front panel RF ON/OFF button, or via the Analog or Serial Interfaces. The text “EXT” is shown on line 2 of the front panel display	<p>The Analog Interface “INTERLOCK” signal is at a TTL “HIGH” state – disabling the RF output.</p> <p>Ensure the Analog Interface Connector is fully seated</p> <p>Apply a TTL “low” signal to pin 2 of the Analog Interface Connector or connect pins 2 and 15 together on Analog Interface Connector.</p>
When in ANALOG control mode, the RF output power is erratic and/or fluctuates.	<p>Ensure the Analog Interface connector GROUND RETURN signal (GNDI, pins 9, 16 and 17) is connected to the system common ground reference.</p> <p>Ensure the Analog Interface connector SETPOINT RETURN signal (SETRET, pin 25) is connected to the</p>

Condition	Suggested Solution
	<p>same ground reference as the SETPOINT source signal (Analog Interface Connector pin 13).</p> <p>The SETPOINT signal is a differential input. For proper operation, the GROUND RETURN (GNDI) and SETRET signals must be referenced to the same ground reference as the setpoint source signal.</p> <p>Ensure the setpoint signal is connected to the Analog Interface Connector with shielded cable.</p>
<p>The text “EXT” is shown on line 2 of the front panel display</p>	<p>The Analog Interface “INTERLOCK” signal is at a TTL “HIGH” state – disabling the RF output.</p> <p>Ensure the Analog Interface Connector is fully seated</p> <p>Apply a TTL “low” signal to pin 2 of the Analog Interface Connector or connect pins 2 and 15 together on Analog Interface Connector.</p>
<p>The text “PAC” is shown on line 2 of the front panel display</p>	<p>The Power Amplifier’s Current limit threshold has been met or exceeded. The RF Power Supply is now limiting forward power to prevent the power amplifier current from increasing.</p> <p>Check the system to see if there is a problem with the load or check the external matching network (if present) and ensure it is operating properly.</p> <p>Decrease the power setpoint.</p>
<p>The text “REF” is shown on line 2 of the front panel display</p>	<p>The Reflected Power Alarm threshold has been met or exceeded. The RF Power Supply is now limiting forward power to prevent reflected power from increasing.</p> <p>Check the system to see if there is a problem with the load or check the external matching network (if present) and ensure it is operating properly.</p> <p>The Reflected Power Alarm threshold is set too low for the current process. Check the process specifications and/or the Reflected Power Alarm threshold setting (refer to the Programmable Parameters section).</p> <p>Decrease the power setpoint.</p>
<p>The text “MAX” is shown on line 2 of the front panel display</p>	<p>The Maximum Power Limit threshold has been met or exceeded.</p> <p>The Maximum Power Limit threshold is set too low for the current process. Check the process specifications and/or the</p>

Condition	Suggested Solution
	<p>Maximum Power Limit threshold setting (refer to the Programmable Parameters section).</p> <p>Decrease the power setpoint.</p>
<p>The text “TMP” is shown on line 2 of the front panel display</p>	<p>The RF Power Supply’s internal temperature sensors have detected an over-temperature condition.</p> <p>Disable the RF Output and allow the unit to cool.</p> <p><u>Air Cooled and Water-Cooled Units:</u></p> <p>Verify the chassis air inlets and air exhausts are not blocked or caked with dust or debris</p> <p><u>Water-Cooled Units Only:</u></p> <p>Verify the solenoid water valve’s power connector is plugged into the rear panel “VALVE” connector.</p> <p>Check the solenoid water valve’s operation. The valve should emit an audible “click” when the RF Output is enabled.</p> <p>Ensure the coolant water <i>supply</i> is connected to the “IN” port on the solenoid water valve. The solenoid water valve is sensitive to flow direction.</p> <p>Verify the coolant water supply temperature is less than 40°C.</p> <p>Ensure the coolant water supply and return is connected to the unit and the coolant water is flowing.</p> <p>The coolant water flow rate may be too low:</p> <p>Check for specified water flow.</p> <p>Check for sharp bends, pinches, or kinks in the coolant supply and return lines.</p> <p>Ensure the inside diameter (I.D.) of the coolant water supply and return lines are at least 3/8” ID.</p> <p>Check the coolant water supply and return path. Ensure the coolant water does not flow through another piece of equipment that may increase the water temperature, restrict, or cut-off the water flow.</p>
<p>The text “XIMP” is shown on line 2 of the front panel display</p>	<p>The Excessive Impedance Detection (XIMP) feature has detected an excessive impedance condition. The XIMP alarm will clear if the XIMP condition is removed, or if the RF output is disabled and re-enabled.</p> <p>Adjust the XIMP Trigger and/or the XIMP Delay parameters to better suit the process (refer to the</p>

Condition	Suggested Solution
	<p>Programmable Parameters section). Disable the XIMP feature (refer to the Programmable Parameters section).</p>
<p>The front panel display is off and the front panel power switch is in the “off” position, but there is the sound of a fan operating.</p>	<p>This is normal. The RF Power Supply is in “stand-by” mode. The display, internal DC Power supply’s output, and RF circuits are disabled but the internal DC power supply’s fan is still operating. Setting the rear panel circuit breaker to the “0” (off) position will completely disable the internal DC power supply.</p>

Technical Data

Specifications and other technical data are listed by model type, and where applicable, by Seren IPS Inc. part number.

RF Power Supply Identification

Seren IPS Inc. manufactures multiple variations of its RF Power Supplies. Variations include output power, output frequency, AC mains voltage, and OEM specific hardware and software features. The basic model type is imprinted on the front panel. Detailed information about the RF Power Supply is located on the ratings plate located on the side panel or top cover.

The version of installed software is shown on the front panel display when the unit is powered-on.

The following configuration information is located on the ratings plate:

- Model Type
- Manufacture Date
- Seren IPS Inc. Part Number (10-digit)
- Serial Number
- Customer Part Number (CPN) (optional)
- AC Mains Voltage, AC Mains Frequency, AC Mains Current
- AC Mains Phase (single or 3-phase), AC Mains Input Power
- Rated Output Power
- Rated Output Frequency
- Software Version

Note: The output frequency range of variable frequency models may be limited per customer or OEM configuration requirements. Output power may be limited per customer or OEM configuration requirements.

R101 Specifications Transformer Power Supply (P/N 9600600002/9600600003)

AC Mains Input Power	<p>Voltage Taps: 98V, 115V, 208V, or 220V; Single-phase, factory configured. Specify desired AC mains voltage at time of order. Voltage taps are set to the most appropriate setting at the factory.</p> <p>Frequency: 47-63 HZ</p> <p>Power required: 750VA Maximum</p> <p>Overcurrent Protection: Rear Panel Circuit Breaker, 2x 3A ¼"x1-1/4" time-delay fuses.</p> <p>Current: 98-125V: 10A Maximum 198-250V: 5A Maximum</p> <p>Inrush Current: 36.2A Nominal</p>
Power Cord Supplied	<p>98-125V Models: 14/3 Type SJT, 2m length, with IEC320-C13 female connector and NEMA 5-15P male plug.</p> <p>198-250V Models: 1/3 Type SJT, 2m length, with IEC320-C13 female connector and NEMA 16-15P male plug.</p>
Output:	<p>Power: High Range: 0 to 100 Watts into 50 Ohms Low Range: 0 to 10 Watts into 50 Ohms</p> <p>Maximum Reflected Power: 50 Watts</p> <p>Frequency: 13.56 MHz, Crystal-Controlled</p> <p>Leveling: Forward Power, Load (Net) Power, External Feedback (RF or DC Probe)</p> <p>Frequency Stability: 0.005% Short-term</p> <p>Power Stability: 0.5% Long Term</p> <p>Output Impedance: 50 Ohms, +/-5 Ohms Nominal</p> <p>Metering Accuracy: (Forward Power) +/- 0.5% Full Scale, +/-3% of Reading</p> <p>Temperature Coefficient: 0.25% per °C</p> <p>Forward Power Regulation: +/- 1% into 50 Ohms</p> <p>Load Tolerance: No oscillation or failure into a mismatch condition.</p>

R101 Specifications Transformer Power Supply (P/N 9600600002/9600600003)

Protection:	Forward power limits on current, transistor power dissipation, and excessive reflected power. Unit is short-circuit and open-circuit protected. Unit is thermally protected.										
Spurious Radiation:	Designed to meet or exceed FCC requirements.										
Harmonics:	-50dBc										
Noise, Hum, and Ripple:	-50dBc										
Pulsing:	0 to 1KHz, 1-Hz Steps; 0 to 100% duty cycle; 50 micro-second minimum pulse										
Environment:	<table border="0"> <tr> <td style="vertical-align: top;">Operating Temperature Ambient:</td> <td style="vertical-align: top;">0 to +40°C</td> </tr> <tr> <td style="vertical-align: top;">Operating Relative Humidity:</td> <td style="vertical-align: top;">10% to 90%, non-condensing</td> </tr> <tr> <td style="vertical-align: top;">Atmospheric Pressure, Operating:</td> <td style="vertical-align: top;">683 mBar minimum (approx 3000m above sea level)</td> </tr> <tr> <td style="vertical-align: top;">Atmospheric Pressure, Storage:</td> <td style="vertical-align: top;">585 mBar minimum (approx 4000m above sea level)</td> </tr> <tr> <td style="vertical-align: top;">Atmospheric Pressure, Transporting:</td> <td style="vertical-align: top;">480 mBar minimum (approx 5000m above sea level)</td> </tr> </table>	Operating Temperature Ambient:	0 to +40°C	Operating Relative Humidity:	10% to 90%, non-condensing	Atmospheric Pressure, Operating:	683 mBar minimum (approx 3000m above sea level)	Atmospheric Pressure, Storage:	585 mBar minimum (approx 4000m above sea level)	Atmospheric Pressure, Transporting:	480 mBar minimum (approx 5000m above sea level)
Operating Temperature Ambient:	0 to +40°C										
Operating Relative Humidity:	10% to 90%, non-condensing										
Atmospheric Pressure, Operating:	683 mBar minimum (approx 3000m above sea level)										
Atmospheric Pressure, Storage:	585 mBar minimum (approx 4000m above sea level)										
Atmospheric Pressure, Transporting:	480 mBar minimum (approx 5000m above sea level)										
Cooling:	Forced Air, 110 CFM										
Interface Connections:	<table border="0"> <tr> <td style="vertical-align: top;">Analog Interface:</td> <td style="vertical-align: top;">25 pin Female D-Sub Connector</td> </tr> <tr> <td style="vertical-align: top;">Serial Interface:</td> <td style="vertical-align: top;">9 pin Female D-Sub Connector</td> </tr> <tr> <td style="vertical-align: top;">DCP (Probe) Input: (Optional)</td> <td style="vertical-align: top;">Female type BNC connector, 0 to -10VDC</td> </tr> <tr> <td style="vertical-align: top;">CEX Input:</td> <td style="vertical-align: top;">Female type BNC connector, 3 to 8V Peak-to-Peak sine wave, 13.56MHz, 50 Ohms Nominal Impedance</td> </tr> <tr> <td style="vertical-align: top;">CEX Output:</td> <td style="vertical-align: top;">Female type BNC connector, 5 to 8V Peak-to-Peak, 13.56MHz into 50 Ohms</td> </tr> </table>	Analog Interface:	25 pin Female D-Sub Connector	Serial Interface:	9 pin Female D-Sub Connector	DCP (Probe) Input: (Optional)	Female type BNC connector, 0 to -10VDC	CEX Input:	Female type BNC connector, 3 to 8V Peak-to-Peak sine wave, 13.56MHz, 50 Ohms Nominal Impedance	CEX Output:	Female type BNC connector, 5 to 8V Peak-to-Peak, 13.56MHz into 50 Ohms
Analog Interface:	25 pin Female D-Sub Connector										
Serial Interface:	9 pin Female D-Sub Connector										
DCP (Probe) Input: (Optional)	Female type BNC connector, 0 to -10VDC										
CEX Input:	Female type BNC connector, 3 to 8V Peak-to-Peak sine wave, 13.56MHz, 50 Ohms Nominal Impedance										
CEX Output:	Female type BNC connector, 5 to 8V Peak-to-Peak, 13.56MHz into 50 Ohms										

R101 Specifications Transformer Power Supply (P/N 9600600002/9600600003)

Power Monitor Scaling:	Forward Power Monitor	Monitor output is linearly proportional to 0 to 100 Watts of forward power. Output scaling is 5.0VDC at 100 Watts (50mV/Watt) or 10.0VDC at 100 Watts (100mV/Watt), depending on the analog voltage range selected. (Default scaling)
	Reflected Power Monitor	Monitor output is linearly proportional to 0 to 100 Watts of reflected power. Output scaling is 5.0VDC at 100 Watts (50mV/Watt) or 10.0VDC at 100 Watts (100mV/Watt), depending on the analog voltage range selected. (Default scaling)
Analog Setpoint Sensitivity:	In Power Control mode, analog setpoint sensitivity is 100 Watts at 5.0VDC (50mV per Watt) or 100 Watts at 10.0VDC (100mV per Watt), depending on the analog voltage range selected.	
Labels:	Safety:	Per customer requirements. Labels may include Hazardous Voltage, Heavy Object
	Identification:	Seren IPS Inc. part number, serial number, and customer part number (optional)
Dimensions inch (mm):	5.25 (133.35) High x 9.50 (241.30) Wide x 18.35 (466.09) Deep. Width without ½-Rack Mounting Brackets: 8.00 (203.2)	
Weight:	43 Lbs (19.5Kg)	

R101 Specifications Switching Power Supply (P/N 9600600004/9600600005)

Protection:	Forward power limits on current, transistor power dissipation, and excessive reflected power. Unit is short-circuit and open-circuit protected. Unit is thermally protected.										
Spurious Radiation:	Designed to meet or exceed FCC requirements.										
Harmonics:	-50dBc										
Noise, Hum, and Ripple:	-50dBc										
Pulsing:	0 to 1KHz, 1-Hz Steps; 0 to 100% duty cycle; 50 micro-second minimum pulse										
Environment:	<table border="0" style="width: 100%;"> <tr> <td style="vertical-align: top;">Operating Temperature Ambient:</td> <td style="vertical-align: top;">0 to +40°C</td> </tr> <tr> <td style="vertical-align: top;">Operating Relative Humidity:</td> <td style="vertical-align: top;">10% to 90%, non-condensing</td> </tr> <tr> <td style="vertical-align: top;">Atmospheric Pressure, Operating:</td> <td style="vertical-align: top;">683 mBar minimum (approx 3000m above sea level)</td> </tr> <tr> <td style="vertical-align: top;">Atmospheric Pressure, Storage:</td> <td style="vertical-align: top;">585 mBar minimum (approx 4000m above sea level)</td> </tr> <tr> <td style="vertical-align: top;">Atmospheric Pressure, Transporting:</td> <td style="vertical-align: top;">480 mBar minimum (approx 5000m above sea level)</td> </tr> </table>	Operating Temperature Ambient:	0 to +40°C	Operating Relative Humidity:	10% to 90%, non-condensing	Atmospheric Pressure, Operating:	683 mBar minimum (approx 3000m above sea level)	Atmospheric Pressure, Storage:	585 mBar minimum (approx 4000m above sea level)	Atmospheric Pressure, Transporting:	480 mBar minimum (approx 5000m above sea level)
Operating Temperature Ambient:	0 to +40°C										
Operating Relative Humidity:	10% to 90%, non-condensing										
Atmospheric Pressure, Operating:	683 mBar minimum (approx 3000m above sea level)										
Atmospheric Pressure, Storage:	585 mBar minimum (approx 4000m above sea level)										
Atmospheric Pressure, Transporting:	480 mBar minimum (approx 5000m above sea level)										
Cooling:	Forced Air, 110 CFM										
Interface Connections:	<table border="0" style="width: 100%;"> <tr> <td style="vertical-align: top;">Analog Interface:</td> <td style="vertical-align: top;">25 pin Female D-Sub Connector</td> </tr> <tr> <td style="vertical-align: top;">Serial Interface:</td> <td style="vertical-align: top;">9 pin Female D-Sub Connector</td> </tr> <tr> <td style="vertical-align: top;">DCP (Probe) Input: (Optional)</td> <td style="vertical-align: top;">Female type BNC connector, 0 to -10VDC</td> </tr> <tr> <td style="vertical-align: top;">CEX Input:</td> <td style="vertical-align: top;">Female type BNC connector, 3 to 8V Peak-to-Peak sine wave, 13.56MHz, 50 Ohm Nominal Impedance</td> </tr> <tr> <td style="vertical-align: top;">CEX Output:</td> <td style="vertical-align: top;">Female type BNC connector, 5 to 8V Peak-to-Peak, 13.56MHz, into 50 Ohms</td> </tr> </table>	Analog Interface:	25 pin Female D-Sub Connector	Serial Interface:	9 pin Female D-Sub Connector	DCP (Probe) Input: (Optional)	Female type BNC connector, 0 to -10VDC	CEX Input:	Female type BNC connector, 3 to 8V Peak-to-Peak sine wave, 13.56MHz, 50 Ohm Nominal Impedance	CEX Output:	Female type BNC connector, 5 to 8V Peak-to-Peak, 13.56MHz, into 50 Ohms
Analog Interface:	25 pin Female D-Sub Connector										
Serial Interface:	9 pin Female D-Sub Connector										
DCP (Probe) Input: (Optional)	Female type BNC connector, 0 to -10VDC										
CEX Input:	Female type BNC connector, 3 to 8V Peak-to-Peak sine wave, 13.56MHz, 50 Ohm Nominal Impedance										
CEX Output:	Female type BNC connector, 5 to 8V Peak-to-Peak, 13.56MHz, into 50 Ohms										

R101 Specifications Switching Power Supply (P/N 9600600004/9600600005)

Power Monitor Scaling:	Forward Power Monitor	Monitor output is linearly proportional to 0 to 100 Watts of forward power. Output scaling is 5.0VDC at 100 Watts (50mV/Watt) or 10.0VDC at 100 Watts (100mV/Watt), depending on the analog voltage range selected. (Default scaling)
	Reflected Power Monitor	Monitor output is linearly proportional to 0 to 100 Watts of reflected power. Output scaling is 5.0VDC at 100 Watts (50mV/Watt) or 10.0VDC at 100 Watts (100mV/Watt), depending on the analog voltage range selected. (Default scaling)
Analog Setpoint Sensitivity:	In Power Control mode, analog setpoint sensitivity is 100 Watts at 5.0VDC (50mV per Watt) or 100 Watts at 10.0VDC (100mV per Watt), depending on the analog voltage range selected.	
Labels:	Safety:	Per customer requirements. Labels may include Hazardous Voltage, Heavy Object
	Identification:	Seren IPS Inc. part number, serial number, and customer part number (optional)
Dimensions inch (mm):	5.25 (133.35) High x 9.50 (241.30) Wide x 18.35 (466.09) Deep. Width without ½-Rack Mounting Brackets: 8.00 (203.2)	
Weight:	27.5 Lbs (12.47Kg)	

R101MKII Specifications

Protection:	Forward power limits on current, transistor power dissipation, and excessive reflected power. Unit is short-circuit and open-circuit protected. Unit is thermally protected.										
Spurious Radiation:	Designed to meet or exceed FCC requirements.										
Harmonics:	-50dBc										
Noise, Hum, and Ripple:	-50dBc										
Pulsing:	0 to 1KHz, 1-Hz Steps; 0 to 100% duty cycle; 50 micro-second minimum pulse										
Environment:	<table border="0"> <tr> <td style="vertical-align: top;">Operating Temperature Ambient:</td> <td style="vertical-align: top;">0 to +40°C</td> </tr> <tr> <td style="vertical-align: top;">Operating Relative Humidity:</td> <td style="vertical-align: top;">10% to 90%, non-condensing</td> </tr> <tr> <td style="vertical-align: top;">Atmospheric Pressure, Operating:</td> <td style="vertical-align: top;">683 mBar minimum (approx 3000m above sea level)</td> </tr> <tr> <td style="vertical-align: top;">Atmospheric Pressure, Storage:</td> <td style="vertical-align: top;">585 mBar minimum (approx 4000m above sea level)</td> </tr> <tr> <td style="vertical-align: top;">Atmospheric Pressure, Transporting:</td> <td style="vertical-align: top;">480 mBar minimum (approx 5000m above sea level)</td> </tr> </table>	Operating Temperature Ambient:	0 to +40°C	Operating Relative Humidity:	10% to 90%, non-condensing	Atmospheric Pressure, Operating:	683 mBar minimum (approx 3000m above sea level)	Atmospheric Pressure, Storage:	585 mBar minimum (approx 4000m above sea level)	Atmospheric Pressure, Transporting:	480 mBar minimum (approx 5000m above sea level)
Operating Temperature Ambient:	0 to +40°C										
Operating Relative Humidity:	10% to 90%, non-condensing										
Atmospheric Pressure, Operating:	683 mBar minimum (approx 3000m above sea level)										
Atmospheric Pressure, Storage:	585 mBar minimum (approx 4000m above sea level)										
Atmospheric Pressure, Transporting:	480 mBar minimum (approx 5000m above sea level)										
Cooling:	Forced Air, 110 CFM										
Interface Connections:	<table border="0"> <tr> <td style="vertical-align: top;">Analog Interface:</td> <td style="vertical-align: top;">25 pin Female D-Sub Connector</td> </tr> <tr> <td style="vertical-align: top;">Serial Interface:</td> <td style="vertical-align: top;">9 pin Female D-Sub Connector</td> </tr> <tr> <td style="vertical-align: top;">DCP (Probe) Input: (Optional)</td> <td style="vertical-align: top;">Female type BNC connector, 0 to -10VDC</td> </tr> <tr> <td style="vertical-align: top;">CEX Input:</td> <td style="vertical-align: top;">Female type BNC connector, 3 to 8V Peak-to-Peak sine wave, 13.56MHz, 50 Ohms Nominal Impedance</td> </tr> <tr> <td style="vertical-align: top;">CEX Output:</td> <td style="vertical-align: top;">Female type BNC connector, 5 to 8V Peak-to-Peak, 13.56MHz, into 50 Ohms</td> </tr> </table>	Analog Interface:	25 pin Female D-Sub Connector	Serial Interface:	9 pin Female D-Sub Connector	DCP (Probe) Input: (Optional)	Female type BNC connector, 0 to -10VDC	CEX Input:	Female type BNC connector, 3 to 8V Peak-to-Peak sine wave, 13.56MHz, 50 Ohms Nominal Impedance	CEX Output:	Female type BNC connector, 5 to 8V Peak-to-Peak, 13.56MHz, into 50 Ohms
Analog Interface:	25 pin Female D-Sub Connector										
Serial Interface:	9 pin Female D-Sub Connector										
DCP (Probe) Input: (Optional)	Female type BNC connector, 0 to -10VDC										
CEX Input:	Female type BNC connector, 3 to 8V Peak-to-Peak sine wave, 13.56MHz, 50 Ohms Nominal Impedance										
CEX Output:	Female type BNC connector, 5 to 8V Peak-to-Peak, 13.56MHz, into 50 Ohms										

R101MKII Specifications

Power Monitor Scaling:	Forward Power Monitor	Monitor output is linearly proportional to 0 to 100 Watts of forward power. Output scaling is 5.0VDC at 100 Watts (50mV/Watt) or 10.0VDC at 100 Watts (100mV/Watt), depending on the analog voltage range selected. (Default scaling)
	Reflected Power Monitor	Monitor output is linearly proportional to 0 to 100 Watts of reflected power. Output scaling is 5.0VDC at 100 Watts (50mV/Watt) or 10.0VDC at 100 Watts (100mV/Watt), depending on the analog voltage range selected. (Default scaling)
Analog Setpoint Sensitivity:	In Power Control mode, analog setpoint sensitivity is 100 Watts at 5.0VDC (50mV per Watt) or 100 Watts at 10.0VDC (100mV per Watt), depending on the analog voltage range selected.	
Labels:	Safety:	Per customer requirements. Labels may include Hazardous Voltage, Heavy Object
	Identification:	Seren IPS Inc. part number, serial number, and customer part number (optional)
Dimensions inch (mm):	5.25 (133.35) High x 9.50 (241.30) Wide x 18.35 (466.09) Deep. Width without ½-Rack Mounting Brackets: 8.00 (203.2)	
Weight:	27 Lbs (12.3Kg)	

R301 Specifications

Protection:	Forward power limits on current, transistor power dissipation, and excessive reflected power. Unit is short-circuit and open-circuit protected. Unit is thermally protected.										
Spurious Radiation:	Designed to meet or exceed FCC requirements.										
Harmonics:	-50dBc										
Noise, Hum, and Ripple:	-50dBc										
Pulsing:	0 to 1KHz, 1-Hz Steps; 0 to 100% duty cycle; 50 micro-second minimum pulse										
Environment:	<table border="0"> <tr> <td style="vertical-align: top;">Operating Temperature Ambient:</td> <td style="vertical-align: top;">0 to +40°C</td> </tr> <tr> <td style="vertical-align: top;">Operating Relative Humidity:</td> <td style="vertical-align: top;">10% to 90%, non-condensing</td> </tr> <tr> <td style="vertical-align: top;">Atmospheric Pressure, Operating:</td> <td style="vertical-align: top;">683 mBar minimum (approx 3000m above sea level)</td> </tr> <tr> <td style="vertical-align: top;">Atmospheric Pressure, Storage:</td> <td style="vertical-align: top;">585 mBar minimum (approx 4000m above sea level)</td> </tr> <tr> <td style="vertical-align: top;">Atmospheric Pressure, Transporting:</td> <td style="vertical-align: top;">480 mBar minimum (approx 5000m above sea level)</td> </tr> </table>	Operating Temperature Ambient:	0 to +40°C	Operating Relative Humidity:	10% to 90%, non-condensing	Atmospheric Pressure, Operating:	683 mBar minimum (approx 3000m above sea level)	Atmospheric Pressure, Storage:	585 mBar minimum (approx 4000m above sea level)	Atmospheric Pressure, Transporting:	480 mBar minimum (approx 5000m above sea level)
Operating Temperature Ambient:	0 to +40°C										
Operating Relative Humidity:	10% to 90%, non-condensing										
Atmospheric Pressure, Operating:	683 mBar minimum (approx 3000m above sea level)										
Atmospheric Pressure, Storage:	585 mBar minimum (approx 4000m above sea level)										
Atmospheric Pressure, Transporting:	480 mBar minimum (approx 5000m above sea level)										
Cooling:	Forced Air, 110 CFM										
Interface Connections:	<table border="0"> <tr> <td style="vertical-align: top;">Analog Interface:</td> <td style="vertical-align: top;">25 pin Female D-Sub Connector</td> </tr> <tr> <td style="vertical-align: top;">Serial Interface:</td> <td style="vertical-align: top;">9 pin Female D-Sub Connector</td> </tr> <tr> <td style="vertical-align: top;">DCP (Probe) Input: (Optional)</td> <td style="vertical-align: top;">Female type BNC connector, 0 to -10VDC</td> </tr> <tr> <td style="vertical-align: top;">CEX Input:</td> <td style="vertical-align: top;">Female type BNC connector, 3 to 8V Peak-to-Peak sine wave, 13.56MHz, 50 Ohms Nominal Impedance</td> </tr> <tr> <td style="vertical-align: top;">CEX Output:</td> <td style="vertical-align: top;">Female type BNC connector, 5 to 8V Peak-to-Peak, 13.56MHz into 50 Ohmx</td> </tr> </table>	Analog Interface:	25 pin Female D-Sub Connector	Serial Interface:	9 pin Female D-Sub Connector	DCP (Probe) Input: (Optional)	Female type BNC connector, 0 to -10VDC	CEX Input:	Female type BNC connector, 3 to 8V Peak-to-Peak sine wave, 13.56MHz, 50 Ohms Nominal Impedance	CEX Output:	Female type BNC connector, 5 to 8V Peak-to-Peak, 13.56MHz into 50 Ohmx
Analog Interface:	25 pin Female D-Sub Connector										
Serial Interface:	9 pin Female D-Sub Connector										
DCP (Probe) Input: (Optional)	Female type BNC connector, 0 to -10VDC										
CEX Input:	Female type BNC connector, 3 to 8V Peak-to-Peak sine wave, 13.56MHz, 50 Ohms Nominal Impedance										
CEX Output:	Female type BNC connector, 5 to 8V Peak-to-Peak, 13.56MHz into 50 Ohmx										

R301 Specifications

Power Monitor Scaling:	Forward Power Monitor	Monitor output is linearly proportional to 0 to 300 Watts of forward power. Output scaling is 5.0VDC at 300 Watts (16.6mV/Watt) or 10.0VDC at 300 Watts (33.3mV/Watt), depending on the analog voltage range selected. (Default scaling)
	Reflected Power Monitor	Monitor output is linearly proportional to 0 to 100 Watts of reflected power. Output scaling is 5.0VDC at 100 Watts (50mV/Watt) or 10.0VDC at 100 Watts (100mV/Watt), depending on the analog voltage range selected. (Default scaling)
Analog Setpoint Sensitivity:	In Power Control mode, analog setpoint sensitivity is 300 Watts at 5.0VDC (16.6mV per Watt) or 300 Watts at 10.0VDC (33.3mV per Watt), depending on the analog voltage range selected.	
Labels:	Safety:	Per customer requirements. Labels may include Hazardous Voltage, Heavy Object
	Identification:	Seren IPS Inc. part number, serial number, and customer part number (optional)
Dimensions inch (mm):	5.25 (133.35) High x 9.50 (241.30) Wide x 18.35 (466.09) Deep. Width without ½-Rack Mounting Brackets: 8.00 (203.2)	
Weight:	43 Lbs (19.5Kg)	

R301MKII Specifications

AC Mains	90-140VAC or 190-264VAC (universal input), Single Phase.	
Input Power	There are no transformer taps to configure. AC mains voltage specified at time of order determines supplied power cord Frequency: 47-63 HZ Power required: 750VA Maximum	
	Overcurrent Protection:	Rear Panel Circuit Breaker, 10A 2x 3A ¼"x1-1/4" time-delay fuses.
	Current:	90-140V: 10A Maximum 190-264V: 5A Nominal
	Inrush Current: 35A Maximum	
Power Cord Supplied	90-140V Applications: 14/3 Type SJT, 2m length, with IEC320-C13 female connector and NEMA 5-15P male plug. 190-264V Applications: 1/3 Type SJT, 2m length, with IEC320-C13 female connector and NEMA 16-15P male plug.	
Output:	Power:	High Range: 0 to 300 Watts into 50 Ohms Low Range: 0 to 30 Watts into 50 Ohms
	Maximum Reflected Power:	50 Watts
	Frequency:	13.56MHz, Fixed
	Leveling:	Forward Power, Load (Net) Power, External Feedback (RF or DC Probe)
	Frequency Stability:	0.005% Short-term
	Power Stability:	0.5% Long Term
	Output Impedance:	50 Ohms, +/-5 Ohms Nominal
	Metering Accuracy: (Forward Power)	+/- 0.5% Full Scale, +/-3% of Reading
	Temperature Coefficient:	0.25% per °C
	Forward Power Regulation:	+/- 1% into 50 Ohms
	Load Tolerance:	No oscillation or failure into a mismatch condition.

R301MKII Specifications

	Protection:	Forward power limits on current, transistor power dissipation, and excessive reflected power. Unit is short-circuit and open-circuit protected. Unit is thermally protected.
	Spurious Radiation:	Designed to meet or exceed FCC requirements.
	Harmonics:	-50dBc
	Noise, Hum, and Ripple:	-50dBc
	Pulsing:	0 to 1KHz, 1-Hz Steps; 0 to 100% duty cycle; 50 micro-second minimum pulse
Environment:	Operating Temperature Ambient:	0 to +40°C
	Operating Relative Humidity:	10% to 90%, non-condensing
	Atmospheric Pressure, Operating:	683 mBar minimum (approx 3000m above sea level)
	Atmospheric Pressure, Storage:	585 mBar minimum (approx 4000m above sea level)
	Atmospheric Pressure, Transporting:	480 mBar minimum (approx 5000m above sea level)
Cooling:	Forced Air, 110 CFM	
Interface Connections:	Analog Interface:	25 pin Female D-Sub Connector
	Serial Interface:	9 pin Female D-Sub Connector
	DCP (Probe) Input: (Optional)	Female type BNC connector, 0 to -10VDC
	CEX Input:	Female type BNC connector, 3 to 8V Peak-to-Peak sine wave, 13.56MHz , 50 Ohms Nominal Impedance
	CEX Output:	Female type BNC connector, 5 to 8V Peak-to-Peak, 13.56MHz into 50 Ohms

R301MKII Specifications

Power Monitor Scaling:	Forward Power Monitor	Monitor output is linearly proportional to 0 to 300 Watts of forward power. Output scaling is 5.0VDC at 300 Watts (16.6mV/Watt) or 10.0VDC at 300 Watts (33.3mV/Watt), depending on the analog voltage range selected. (Default scaling)
	Reflected Power Monitor	Monitor output is linearly proportional to 0 to 100 Watts of reflected power. Output scaling is 5.0VDC at 100 Watts (50mV/Watt) or 10.0VDC at 100 Watts (100mV/Watt), depending on the analog voltage range selected. (Default scaling)
Analog Setpoint Sensitivity:	In Power Control mode, analog setpoint sensitivity is 300 Watts at 5.0VDC (16.6mV per Watt) or 300 Watts at 10.0VDC (33.3mV per Watt), depending on the analog voltage range selected.	
Labels:	Safety:	Per customer requirements. Labels may include Hazardous Voltage, Heavy Object
	Identification:	Seren IPS Inc. part number, serial number, and customer part number (optional)
Dimensions inch (mm):	5.25 (133.35) High x 9.50 (241.30) Wide x 18.35 (466.09) Deep. Width without ½-Rack Mounting Brackets: 8.00 (203.2)	
Weight:	27 Lbs (12.3Kg)	

L301 Specifications

AC Mains Input Power	<p>Voltage Taps: 98V, 115V, 208V, or 220V; Single-phase, factory configured. Specify desired AC mains voltage at time of order. Voltage taps are set to the most appropriate setting at the factory.</p> <p>Frequency: 47-63 HZ</p> <p>Power required: 750VA Maximum</p> <p>Overcurrent Protection: Rear Panel Circuit Breaker, 2x 3A ¼"x1-1/4" time-delay fuses.</p> <p>Current: 98-125V: 10A Maximum 198-250V: 5A Maximum</p> <p>Inrush Current: 36.2A Nominal</p>
Power Cord Supplied	<p>98-125V Models: 14/3 Type SJT, 2m length, with IEC320-C13 female connector and NEMA 5-15P male plug.</p> <p>198-250V Models: 1/3 Type SJT, 2m length, with IEC320-C13 female connector and NEMA 16-15P male plug.</p>
Output:	<p>Power: High Range: 0 to 300 Watts into 50 Ohms Low Range: 0 to 30 Watts into 50 Ohms</p> <p>Maximum Reflected Power: 50 Watts</p> <p>Frequency: 100KHz to 460KHz, 1 KHz steps, Frequency Synthesized.</p> <p>Leveling: Forward Power, Load (Net) Power, External Feedback (RF or DC Probe)</p> <p>Frequency Stability: 0.005% Short-term</p> <p>Power Stability: 0.5% Long Term</p> <p>Output Impedance: 50 Ohms, +/-5 Ohms Nominal</p> <p>Metering Accuracy: +/- 0.5% Full Scale, (Forward Power) +/-3% of Reading</p> <p>Temperature Coefficient: 0.25% per °C</p> <p>Forward Power Regulation: +/- 1% into 50 Ohms</p> <p>Load Tolerance: No oscillation or failure into a mismatch condition.</p>

L301 Specifications

Protection:	Forward power limits on current, transistor power dissipation, and excessive reflected power. Unit is short-circuit and open-circuit protected. Unit is thermally protected.										
Spurious Radiation:	Designed to meet or exceed FCC requirements.										
Harmonics:	Equal to or less than -40dBc at maximum output frequency										
Noise, Hum, and Ripple:	-50dBc										
Pulsing:	0 to 1KHz, 1-Hz Steps; 0 to 100% duty cycle; 50 micro-second minimum pulse										
Environment:	<table border="0" style="width: 100%;"> <tr> <td style="vertical-align: top;">Operating Temperature Ambient:</td> <td style="vertical-align: top;">0 to +40°C</td> </tr> <tr> <td style="vertical-align: top;">Operating Relative Humidity:</td> <td style="vertical-align: top;">10% to 90%, non-condensing</td> </tr> <tr> <td style="vertical-align: top;">Atmospheric Pressure, Operating:</td> <td style="vertical-align: top;">683 mBar minimum (approx 3000m above sea level)</td> </tr> <tr> <td style="vertical-align: top;">Atmospheric Pressure, Storage:</td> <td style="vertical-align: top;">585 mBar minimum (approx 4000m above sea level)</td> </tr> <tr> <td style="vertical-align: top;">Atmospheric Pressure, Transporting:</td> <td style="vertical-align: top;">480 mBar minimum (approx 5000m above sea level)</td> </tr> </table>	Operating Temperature Ambient:	0 to +40°C	Operating Relative Humidity:	10% to 90%, non-condensing	Atmospheric Pressure, Operating:	683 mBar minimum (approx 3000m above sea level)	Atmospheric Pressure, Storage:	585 mBar minimum (approx 4000m above sea level)	Atmospheric Pressure, Transporting:	480 mBar minimum (approx 5000m above sea level)
Operating Temperature Ambient:	0 to +40°C										
Operating Relative Humidity:	10% to 90%, non-condensing										
Atmospheric Pressure, Operating:	683 mBar minimum (approx 3000m above sea level)										
Atmospheric Pressure, Storage:	585 mBar minimum (approx 4000m above sea level)										
Atmospheric Pressure, Transporting:	480 mBar minimum (approx 5000m above sea level)										
Cooling:	Forced Air, 110 CFM										
Interface Connections:	<table border="0" style="width: 100%;"> <tr> <td style="vertical-align: top;">Analog Interface:</td> <td style="vertical-align: top;">25 pin Female D-Sub Connector</td> </tr> <tr> <td style="vertical-align: top;">Serial Interface:</td> <td style="vertical-align: top;">9 pin Female D-Sub Connector</td> </tr> <tr> <td style="vertical-align: top;">DCP (Probe) Input: (Optional)</td> <td style="vertical-align: top;">Female type BNC connector, 0 to -10VDC</td> </tr> <tr> <td style="vertical-align: top;">CEX Input:</td> <td style="vertical-align: top;">Female type BNC connector, 3 to 8V Peak-to-Peak sine wave, 100-460KHz, 50 Ohms nominal Impedance</td> </tr> <tr> <td style="vertical-align: top;">CEX Output:</td> <td style="vertical-align: top;">Female type BNC connector, 5 to 8V Peak-to-Peak, 100-460KHz, into 50 Ohms</td> </tr> </table>	Analog Interface:	25 pin Female D-Sub Connector	Serial Interface:	9 pin Female D-Sub Connector	DCP (Probe) Input: (Optional)	Female type BNC connector, 0 to -10VDC	CEX Input:	Female type BNC connector, 3 to 8V Peak-to-Peak sine wave, 100-460KHz, 50 Ohms nominal Impedance	CEX Output:	Female type BNC connector, 5 to 8V Peak-to-Peak, 100-460KHz, into 50 Ohms
Analog Interface:	25 pin Female D-Sub Connector										
Serial Interface:	9 pin Female D-Sub Connector										
DCP (Probe) Input: (Optional)	Female type BNC connector, 0 to -10VDC										
CEX Input:	Female type BNC connector, 3 to 8V Peak-to-Peak sine wave, 100-460KHz, 50 Ohms nominal Impedance										
CEX Output:	Female type BNC connector, 5 to 8V Peak-to-Peak, 100-460KHz, into 50 Ohms										

L301 Specifications

Power Monitor Scaling:	Forward Power Monitor	Monitor output is linearly proportional to 0 to 300 Watts of forward power. Output scaling is 5.0VDC at 300 Watts (16.6mV/Watt) or 10.0VDC at 300 Watts (33.3mV/Watt), depending on the analog voltage range selected. (Default scaling)
	Reflected Power Monitor	Monitor output is linearly proportional to 0 to 100 Watts of reflected power. Output scaling is 5.0VDC at 100 Watts (50mV/Watt) or 10.0VDC at 100 Watts (100mV/Watt), depending on the analog voltage range selected. (Default scaling)
Analog Setpoint Sensitivity:	In Power Control mode, analog setpoint sensitivity is 300 Watts at 5.0VDC (16.6mV per Watt) or 300 Watts at 10.0VDC (33.3mV per Watt), depending on the analog voltage range selected.	
Labels:	Safety:	Per customer requirements. Labels may include Hazardous Voltage, Heavy Object
	Identification:	Seren IPS Inc. part number, serial number, and customer part number (optional)
Dimensions inch (mm):	5.25 (133.35) High x 9.50 (241.30) Wide x 18.35 (466.09) Deep. Width without ½-Rack Mounting Brackets: 8.00 (203.2)	
Weight:	43 Lbs (19.5Kg)	

L301MKII Specifications

AC Mains	90-140VAC or 190-264VAC (universal input), Single Phase.	
Input Power	There are no transformer taps to configure. AC mains voltage specified at time of order determines supplied power cord Frequency: 47-63 HZ Power required: 750VA Maximum Overcurrent Protection: Rear Panel Circuit Breaker, 10A 2x 3A 1/4"x1-1/4" time-delay fuses.	
	Current:	90-140V: 10A Maximum 190-264V: 5A Nominal
	Inrush Current:	35A Maximum
Power Cord Supplied	90-140V Applications: 14/3 Type SJT, 2m length, with IEC320-C13 female connector and NEMA 5-15P male plug. 190-264V Applications: 1/3 Type SJT, 2m length, with IEC320-C13 female connector and NEMA 16-15P male plug.	
Output:	Power:	High Range: 0 to 300 Watts into 50 Ohms Low Range: 0 to 30 Watts into 50 Ohms
	Maximum Reflected Power:	50 Watts
	Frequency:	100KHz to 460KHz, 1 KHz steps, Frequency Synthesized.
	Leveling:	Forward Power, Load (Net) Power, External Feedback (RF or DC Probe)
	Frequency Stability:	0.005% Short-term
	Power Stability:	0.5% Long Term
	Output Impedance:	50 Ohms, +/-5 Ohms Nominal
	Metering Accuracy: (Forward Power)	+/- 0.5% Full Scale, +/-3% of Reading
	Temperature Coefficient:	0.25% per °C
	Forward Power Regulation:	+/- 1% into 50 Ohms
	Load Tolerance:	No oscillation or failure into a mismatch condition.

L301MKII Specifications

Protection:	Forward power limits on current, transistor power dissipation, and excessive reflected power. Unit is short-circuit and open-circuit protected. Unit is thermally protected.										
Spurious Radiation:	Designed to meet or exceed FCC requirements.										
Harmonics:	Equal to or less than -40dBc at maximum output frequency										
Noise, Hum, and Ripple:	-50dBc										
Pulsing:	0 to 1KHz, 1-Hz Steps; 0 to 100% duty cycle; 50 micro-second minimum pulse										
Environment:	<table border="0" style="width: 100%;"> <tr> <td style="vertical-align: top;">Operating Temperature Ambient:</td> <td>0 to +40°C</td> </tr> <tr> <td style="vertical-align: top;">Operating Relative Humidity:</td> <td>10% to 90%, non-condensing</td> </tr> <tr> <td style="vertical-align: top;">Atmospheric Pressure, Operating:</td> <td>683 mBar minimum (approx 3000m above sea level)</td> </tr> <tr> <td style="vertical-align: top;">Atmospheric Pressure, Storage:</td> <td>585 mBar minimum (approx 4000m above sea level)</td> </tr> <tr> <td style="vertical-align: top;">Atmospheric Pressure, Transporting:</td> <td>480 mBar minimum (approx 5000m above sea level)</td> </tr> </table>	Operating Temperature Ambient:	0 to +40°C	Operating Relative Humidity:	10% to 90%, non-condensing	Atmospheric Pressure, Operating:	683 mBar minimum (approx 3000m above sea level)	Atmospheric Pressure, Storage:	585 mBar minimum (approx 4000m above sea level)	Atmospheric Pressure, Transporting:	480 mBar minimum (approx 5000m above sea level)
Operating Temperature Ambient:	0 to +40°C										
Operating Relative Humidity:	10% to 90%, non-condensing										
Atmospheric Pressure, Operating:	683 mBar minimum (approx 3000m above sea level)										
Atmospheric Pressure, Storage:	585 mBar minimum (approx 4000m above sea level)										
Atmospheric Pressure, Transporting:	480 mBar minimum (approx 5000m above sea level)										
Cooling:	Forced Air, 110 CFM										
Interface Connections:	<table border="0" style="width: 100%;"> <tr> <td style="vertical-align: top;">Analog Interface:</td> <td>25 pin Female D-Sub Connector</td> </tr> <tr> <td style="vertical-align: top;">Serial Interface:</td> <td>9 pin Female D-Sub Connector</td> </tr> <tr> <td style="vertical-align: top;">DCP (Probe) Input: (Optional)</td> <td>Female type BNC connector, 0 to -10VDC</td> </tr> <tr> <td style="vertical-align: top;">CEX Input:</td> <td>Female type BNC connector, 3 to 8V Peak-to-Peak sine wave, 13.56MHz, 50 Ohms Nominal Impedance</td> </tr> <tr> <td style="vertical-align: top;">CEX Output:</td> <td>Female type BNC connector, 5 to 8V Peak-to-Peak, 13.56MHz, into 50 Ohms</td> </tr> </table>	Analog Interface:	25 pin Female D-Sub Connector	Serial Interface:	9 pin Female D-Sub Connector	DCP (Probe) Input: (Optional)	Female type BNC connector, 0 to -10VDC	CEX Input:	Female type BNC connector, 3 to 8V Peak-to-Peak sine wave, 13.56MHz, 50 Ohms Nominal Impedance	CEX Output:	Female type BNC connector, 5 to 8V Peak-to-Peak, 13.56MHz, into 50 Ohms
Analog Interface:	25 pin Female D-Sub Connector										
Serial Interface:	9 pin Female D-Sub Connector										
DCP (Probe) Input: (Optional)	Female type BNC connector, 0 to -10VDC										
CEX Input:	Female type BNC connector, 3 to 8V Peak-to-Peak sine wave, 13.56MHz, 50 Ohms Nominal Impedance										
CEX Output:	Female type BNC connector, 5 to 8V Peak-to-Peak, 13.56MHz, into 50 Ohms										

L301MKII Specifications

Power Monitor Scaling:	Forward Power Monitor	Monitor output is linearly proportional to 0 to 300 Watts of forward power. Output scaling is 5.0VDC at 300 Watts (16.6mV/Watt) or 10.0VDC at 300 Watts (33.3mV/Watt), depending on the analog voltage range selected. (Default scaling)
	Reflected Power Monitor	Monitor output is linearly proportional to 0 to 100 Watts of reflected power. Output scaling is 5.0VDC at 100 Watts (50mV/Watt) or 10.0VDC at 100 Watts (100mV/Watt), depending on the analog voltage range selected. (Default scaling)
Analog Setpoint Sensitivity:	In Power Control mode, analog setpoint sensitivity is 300 Watts at 5.0VDC (16.6mV per Watt) or 300 Watts at 10.0VDC (33.3mV per Watt), depending on the analog voltage range selected.	
Labels:	Safety:	Per customer requirements. Labels may include Hazardous Voltage, Heavy Object
	Identification:	Seren IPS Inc. part number, serial number, and customer part number (optional)
Dimensions inch (mm):	5.25 (133.35) High x 9.50 (241.30) Wide x 18.35 (466.09) Deep. Width without ½-Rack Mounting Brackets: 8.00 (203.2)	
Weight:	27 Lbs (12.3Kg)	

R601 Specifications

AC Mains	Voltage: 90-125V or 190-264V (universal input), Single Phase.	
Input Power	There are no transformer voltage taps to configure. AC mains voltage specified at time of order determines supplied power cord Frequency: 47-63 HZ Current: 15A Maximum. Power required: 1360VA Maximum	
	Overcurrent Protection:	Rear Panel Circuit Breaker, 2x 1.5A 1/4"x1-1/4" time-delay fuses.
Power Cord Supplied (specified at time of order)	90-125V: 14/3 Type SJT, 2m length, with IEC320-C13 female connector to NEMA 5-15P plug. Seren P/N 4500910000 190-264V: 14/3 Type SJT, 2m length, with IEC320-C13 female connector to NEMA L6-15P plug. Seren P/N 4500910001	
Output:	Power:	High Range: 0 to 600 Watts into 50 Ohms Low Range: 0 to 60 Watts into 50 Ohms
	Maximum Reflected Power:	100 Watts
	Frequency:	13.56 MHz, Fixed.
	Leveling:	Forward Power, Load (Net) Power, External Feedback (RF or DC Probe)
	Frequency Stability:	0.005% Short-term
	Power Stability:	0.5% Long Term, +/- 1 Watt
	Output Impedance:	50 Ohms, +/-5 Ohms Nominal
	Metering Accuracy: (Forward Power)	+/- 1% Full Scale, +/- 1% of Reading
	Temperature Coefficient:	0.25% per °C
	Forward Power Regulation:	+/- 1% into 50 Ohms
	Load Tolerance:	No oscillation or failure into a mismatch condition.
	Protection:	Forward power limits on current, transistor power dissipation, and excessive reflected power. Unit is short-circuit and open-circuit protected. Unit is thermally protected.

R601 Specifications

	Spurious Radiation:	Designed to meet or exceed FCC requirements.
	Harmonics:	-50dBc
	Noise, Hum, and Ripple:	-50dBc
	Pulsing:	0 to 1KHz, 1-Hz Steps; 0 to 100% duty cycle; 50 micro-second minimum pulse
Environment:	Operating Temperature Ambient:	0 to +40°C
	Operating Relative Humidity:	10% to 90%, non-condensing
	Atmospheric Pressure, Operating:	683 mBar minimum (approx 3000m above sea level)
	Atmospheric Pressure, Storage:	585 mBar minimum (approx 4000m above sea level)
	Atmospheric Pressure, Transporting:	480 mBar minimum (approx 5000m above sea level)
Cooling:	Forced Air, 110 CFM (52 L/sec)	
Interface Connections:	Analog Interface:	25 pin Female D-Sub Connector
	Serial Interface:	9 pin Female D-Sub Connector
	CEX Input:	Female type BNC connector, 3 to 8V Peak-to-Peak sine wave, 13.56MHz, 50 Ohms Nominal Impedance
	CEX Output:	Female type BNC connector, 5 to 8V Peak-to-Peak, 13.56MHz into 50 Ohms.
Power Monitor Scaling:	Forward Power Monitor	Monitor output is linearly proportional to 0 to 600 Watts of forward power. Output scaling is 5.0VDC at 600 Watts (8.33mV/Watt) or 10.0VDC at 600 Watts (16.6mV/Watt), depending on the analog voltage range selected. (Default scaling)

R601 Specifications

Reflected Power Monitor	Monitor output is linearly proportional to 0 to 100 Watts of reflected power. Output scaling is 5.0VDC at 100 Watts (50mV/Watt) or 10.0VDC at 100 Watts (100mV/Watt), depending on the analog voltage range selected. (Default scaling)				
Analog Setpoint Sensitivity:	In Power Control mode, analog setpoint sensitivity is 600 Watts at 5.0VDC (8.33mV per Watt) or 600 Watts at 10.0VDC (16.6mV per Watt), depending on the analog voltage range selected.				
Labels:	<table border="0" style="width: 100%;"> <tr> <td style="vertical-align: top; padding-right: 20px;">Safety:</td> <td>Per customer requirements. Labels may include Hazardous Voltage, Heavy Object</td> </tr> <tr> <td style="vertical-align: top; padding-right: 20px;">Identification:</td> <td>Seren IPS Inc. part number, serial number, and customer part number (optional)</td> </tr> </table>	Safety:	Per customer requirements. Labels may include Hazardous Voltage, Heavy Object	Identification:	Seren IPS Inc. part number, serial number, and customer part number (optional)
Safety:	Per customer requirements. Labels may include Hazardous Voltage, Heavy Object				
Identification:	Seren IPS Inc. part number, serial number, and customer part number (optional)				
Dimensions inch (mm):	7.00 (133.35) High x 9.50 (241.30) Wide x 18.38 (466.85) Deep. Width includes ½-Rack Mounting Brackets. Width without ½-Rack Mounting Brackets: 8.00 (203.2)				
Weight:	37 Lbs (16.8Kg)				

L601 Specifications

AC Mains	Voltage: 90-125V or 190-264V (universal input), Single Phase.	
Input Power	There are no transformer voltage taps to configure.	
	AC mains voltage specified at time of order determines supplied power cord	
	Frequency: 47-63 HZ	
	Current: 15A Maximum.	
	Power required: 1360VA Maximum	
	Overcurrent Protection:	Rear Panel Circuit Breaker, 2x 1.5A 1/4"x1-1/4" time-delay fuses.
Power Cord Supplied: (specify at time of order)	90-125V:	14/3 Type SJT, 2m length, with IEC320-C13 female connector to NEMA 5-15P plug. Seren P/N 4500910000
	190-264V:	14/3 Type SJT, 2m length, with IEC320-C13 female connector to NEMA L6-15P plug. Seren P/N 4500910001
Output:	Power:	High Range: 0 to 600 Watts into 50 Ohms Low Range: 0 to 60 Watts into 50 Ohms
	Maximum Reflected Power:	100 Watts
	Frequency:	100KHz to 460KHz, 1 KHz Steps, Frequency Synthesized
	Leveling:	Forward Power, Load (Net) Power, External Feedback (RF or DC Probe)
	Frequency Stability:	0.005% Short-term
	Power Stability:	0.5% Long Term, +/- 1 Watt
	Output Impedance:	50 Ohms, +/-5 Ohms Nominal
	Metering Accuracy: (Forward Power)	+/- 1% Full Scale, +/- 1% of Reading
	Temperature Coefficient:	0.25% per °C
	Forward Power Regulation:	+/- 1% into 50 Ohms
	Load Tolerance:	No oscillation or failure into a mismatch condition.

L601 Specifications

Protection:	Forward power limits on current, transistor power dissipation, and excessive reflected power. Unit is short-circuit and open-circuit protected. Unit is thermally protected.										
Spurious Radiation:	Designed to meet or exceed FCC requirements.										
Harmonics:	Equal to or less than -40dBc at maximum output frequency										
Noise, Hum, and Ripple:	-50dBc										
Pulsing:	0 to 1KHz, 1-Hz Steps; 0 to 100% duty cycle; 50 micro-second minimum pulse										
Environment:	<table border="0" style="width: 100%;"> <tr> <td style="vertical-align: top;">Operating Temperature Ambient:</td> <td style="vertical-align: top;">0 to +40°C</td> </tr> <tr> <td style="vertical-align: top;">Operating Relative Humidity:</td> <td style="vertical-align: top;">10% to 90%, non-condensing</td> </tr> <tr> <td style="vertical-align: top;">Atmospheric Pressure, Operating:</td> <td style="vertical-align: top;">683 mBar minimum (approx 3000m above sea level)</td> </tr> <tr> <td style="vertical-align: top;">Atmospheric Pressure, Storage:</td> <td style="vertical-align: top;">585 mBar minimum (approx 4000m above sea level)</td> </tr> <tr> <td style="vertical-align: top;">Atmospheric Pressure, Transporting:</td> <td style="vertical-align: top;">480 mBar minimum (approx 5000m above sea level)</td> </tr> </table>	Operating Temperature Ambient:	0 to +40°C	Operating Relative Humidity:	10% to 90%, non-condensing	Atmospheric Pressure, Operating:	683 mBar minimum (approx 3000m above sea level)	Atmospheric Pressure, Storage:	585 mBar minimum (approx 4000m above sea level)	Atmospheric Pressure, Transporting:	480 mBar minimum (approx 5000m above sea level)
Operating Temperature Ambient:	0 to +40°C										
Operating Relative Humidity:	10% to 90%, non-condensing										
Atmospheric Pressure, Operating:	683 mBar minimum (approx 3000m above sea level)										
Atmospheric Pressure, Storage:	585 mBar minimum (approx 4000m above sea level)										
Atmospheric Pressure, Transporting:	480 mBar minimum (approx 5000m above sea level)										
Cooling:	Forced Air, 110 CFM (52 L/sec)										
Interface Connections:	<table border="0" style="width: 100%;"> <tr> <td style="vertical-align: top;">Analog Interface:</td> <td style="vertical-align: top;">25 pin Female D-Sub Connector</td> </tr> <tr> <td style="vertical-align: top;">Serial Interface:</td> <td style="vertical-align: top;">9 pin Female D-Sub Connector</td> </tr> <tr> <td style="vertical-align: top;">CEX Input:</td> <td style="vertical-align: top;">Female type BNC connector, 3 to 8V Peak-to-Peak sine wave, 100-460KHz, 50 Ohms Nominal Impedance</td> </tr> <tr> <td style="vertical-align: top;">CEX Output:</td> <td style="vertical-align: top;">Female type BNC connector, 5 to 8V Peak-to-Peak, 100-460KHz into 50 Ohms</td> </tr> </table>	Analog Interface:	25 pin Female D-Sub Connector	Serial Interface:	9 pin Female D-Sub Connector	CEX Input:	Female type BNC connector, 3 to 8V Peak-to-Peak sine wave, 100-460KHz, 50 Ohms Nominal Impedance	CEX Output:	Female type BNC connector, 5 to 8V Peak-to-Peak, 100-460KHz into 50 Ohms		
Analog Interface:	25 pin Female D-Sub Connector										
Serial Interface:	9 pin Female D-Sub Connector										
CEX Input:	Female type BNC connector, 3 to 8V Peak-to-Peak sine wave, 100-460KHz, 50 Ohms Nominal Impedance										
CEX Output:	Female type BNC connector, 5 to 8V Peak-to-Peak, 100-460KHz into 50 Ohms										

L601 Specifications

Power Monitor Scaling:	Forward Power Monitor	Monitor output is linearly proportional to 0 to 600 Watts of forward power. Output scaling is 5.0VDC at 600 Watts (8.33mV/Watt) or 10.0VDC at 600 Watts (16.6mV/Watt), depending on the analog voltage range selected. (Default scaling)
	Reflected Power Monitor	Monitor output is linearly proportional to 0 to 100 Watts of reflected power. Output scaling is 5.0VDC at 100 Watts (50mV/Watt) or 10.0VDC at 100 Watts (100mV/Watt), depending on the analog voltage range selected. (Default scaling)
Analog Setpoint Sensitivity:	In Power Control mode, analog setpoint sensitivity is 600 Watts at 5.0VDC (8.33mV per Watt) or 600 Watts at 10.0VDC (16.6mV per Watt), depending on the analog voltage range selected.	
Labels:	Safety:	Per customer requirements. Labels may include Hazardous Voltage, Heavy Object
	Identification:	Seren IPS Inc. part number, serial number, and customer part number (optional)
Dimensions inch (mm):	7.00 (133.35) High x 9.50 (241.30) Wide x 18.38 (466.85) Deep. Width includes ½-Rack Mounting Brackets. Width without ½-Rack Mounting Brackets: 8.00 (203.2)	
Weight:	37 Lbs (16.8Kg)	

R1001 Specifications

AC Mains	Voltage: 190-264V, Single Phase.	
Input Power	There are no transformer voltage taps to configure.	
	Frequency: 47-63 HZ	
	Current: 15A Maximum.	
	Power required: 1650VA Maximum	
	Overcurrent Protection:	Rear Panel Circuit Breaker, 2x 1.5A 1/4"x1-1/4" time-delay fuses.
Power Cord Supplied	190-264V: 14/3 Type SJT, 2m length, with IEC320-C13 female connector to NEMA L6-15P plug. Seren P/N 4500910001	
Output:	Power:	High Range: 0 to 1000 Watts into 50 Ohms Low Range: 0 to 100 Watts into 50 Ohms
	Maximum Reflected Power:	100 Watts
	Frequency:	13.56 MHz, Fixed.
	Leveling:	Forward Power, Load (Net) Power, External Feedback (RF or DC Probe)
	Frequency Stability:	0.005% Short-term
	Power Stability:	0.5% Long Term, +/- 1 Watt
	Output Impedance:	50 Ohms, +/-5 Ohms Nominal
	Metering Accuracy: (Forward Power)	+/- 1% Full Scale, +/- 1% of Reading
	Temperature Coefficient:	0.25% per °C
	Forward Power Regulation:	+/- 1% into 50 Ohms
	Load Tolerance:	No oscillation or failure into a mismatch condition.
	Protection:	Forward power limits on current, transistor power dissipation, and excessive reflected power. Unit is short-circuit and open-circuit protected. Unit is thermally protected.
	Spurious Radiation:	Designed to meet or exceed FCC requirements.
	Harmonics:	-50dBc

R1001 Specifications

	Noise, Hum, and Ripple:	-50dBc
	Pulsing:	0 to 1KHz, 1-Hz Steps; 0 to 100% duty cycle; 50 micro-second minimum pulse
Environment:	Operating Temperature Ambient:	0 to +40°C
	Operating Relative Humidity:	10% to 90%, non-condensing
	Atmospheric Pressure, Operating:	683 mBar minimum (approx 3000m above sea level)
	Atmospheric Pressure, Storage:	585 mBar minimum (approx 4000m above sea level)
	Atmospheric Pressure, Transporting:	480 mBar minimum (approx 5000m above sea level)
Cooling:	Forced Air, 110 CFM (52 L/sec)	
Interface Connections:	Analog Interface:	25 pin Female D-Sub Connector
	Serial Interface:	9 pin Female D-Sub Connector
	CEX Input:	Female type BNC connector, 3 to 8V Peak-to-Peak sine wave, 13.56MHz, 50 Ohms Nominal Impedance
	CEX Output:	Female type BNC connector, 5 to 8V Peak-to-Peak, 13.56MHz into 50 Ohms
Power Monitor Scaling:	Forward Power Monitor	Monitor output is linearly proportional to 0 to 1000 Watts of forward power. Output scaling is 5.0VDC at 1000 Watts (5.0mV/Watt) or 10.0VDC at 1000 Watts (10mV/Watt), depending on the analog voltage range selected. (Default scaling)

R1001 Specifications

Reflected Power Monitor Monitor output is linearly proportional to 0 to 100 Watts of reflected power.
 Output scaling is 5.0VDC at 100 Watts (50mV/Watt) or 10.0VDC at 100 Watts (100mV/Watt), depending on the analog voltage range selected. (Default scaling)

Analog Setpoint Sensitivity: In Power Control mode, analog setpoint sensitivity is 1000 Watts at 5.0VDC (5.0mV per Watt) or 1000 Watts at 10.0VDC (10mV per Watt), depending on the analog voltage range selected.

Labels: Safety: Per customer requirements. Labels may include Hazardous Voltage, Heavy Object
 Identification: Seren IPS Inc. part number, serial number, and customer part number (optional)

Dimensions inch (mm): 7.00 (133.35) High x 9.50 (241.30) Wide x 18.38 (466.85) Deep. Width includes ½-Rack Mounting Brackets.
 Width without ½-Rack Mounting Brackets: 8.00 (203.2)

Weight: 37 Lbs (16.8Kg)

R1001W Specifications

AC Mains	Voltage: 190-264V, Single Phase.	
Input Power	There are no transformer voltage taps to configure.	
	Frequency: 47-63 HZ	
	Current: 15A Maximum.	
	Power required: 1650VA Maximum	
	Overcurrent Protection:	Rear Panel Circuit Breaker, 2x 1.5A 1/4"x1-1/4" time-delay fuses.
Power Cord Supplied	190-264V: 14/3 Type SJT, 2m length, with IEC320-C13 female connector to NEMA L6-15P plug. Seren P/N 4500910001	
Output:	Power:	High Range: 0 to 1200 Watts into 50 Ohms Low Range: 0 to 120 Watts into 50 Ohms
	Maximum Reflected Power:	150 Watts
	Frequency:	13.56 MHz, Fixed.
	Leveling:	Forward Power, Load (Net) Power, External Feedback (RF or DC Probe)
	Frequency Stability:	0.005% Short-term
	Power Stability:	0.5% Long Term, +/- 1 Watt
	Output Impedance:	50 Ohms, +/-5 Ohms Nominal
	Metering Accuracy: (Forward Power)	+/- 1% Full Scale, +/- 1% of Reading
	Temperature Coefficient:	0.25% per °C
	Forward Power Regulation:	+/- 1% into 50 Ohms
	Load Tolerance:	No oscillation or failure into a mismatch condition.
	Protection:	Forward power limits on current, transistor power dissipation, and excessive reflected power. Unit is short-circuit and open-circuit protected. Unit is thermally protected.
	Spurious Radiation:	Designed to meet or exceed FCC requirements.
	Harmonics:	-50dBc

R1001W Specifications

	Noise, Hum, and Ripple:	-50dBc
	Pulsing:	0 to 1KHz, 1-Hz Steps; 0 to 100% duty cycle; 50 micro-second minimum pulse
Environment:	Operating Temperature Ambient:	0 to +40°C
	Operating Relative Humidity:	10% to 90%, non-condensing
	Atmospheric Pressure, Operating:	683 mBar minimum (approx 3000m above sea level)
	Atmospheric Pressure, Storage:	585 mBar minimum (approx 4000m above sea level)
	Atmospheric Pressure, Transporting:	480 mBar minimum (approx 5000m above sea level)
Cooling:	Ventilation:	Forced Air, 47 CFM, intake at sides, exhaust at rear panel. Observe specified panel clearances and mounting instructions
	Coolant Water:	Flow: 1.2 gallon/minute minimum. Inlet Temperature: +15°C minimum to +40°C maximum temperature, +22°C to +28°C recommended.
	Coolant Water Purity:	pH: Between 7 and 9 Total Chlorine: <20ppm Total Nitrate: <10ppm Total Sulfate: <100ppm Total Dissolved Solids: <250ppm Total Hardness expressed as Calcium Carbonate equivalent: <250ppm Specific Resistivity: >2500 Ohms/cm @ +25°C
	Coolant Water Fittings:	Type 3/8" N.P.T. Female threaded pipe
	Coolant Water Supply Line Inside Diameter:	3/8" [9.52mm] Inside Diameter (I.D.) or larger.
	Waste Heat into Coolant Water	750 Watts maximum. Note: The waste heat does not peak at 1200 Watts of output power - the waste heat peaks at 50% to 80% of full power or under certain reflected power conditions.

R1001W Specifications

Interlocks:	External:	External interlock provided for disabling RF output power
	Valve (optional):	Prevents/disables RF Power output if external water valve is missing or un plugged. (Standard units ignore this interlock – consult factory if valve interlock is required)
Interface Connections:	Analog Interface:	25 pin Female D-Sub Connector
	Serial Interface:	9 pin Female D-Sub Connector
	CEX Input:	Female type BNC connector, 3 to 8V Peak-to-Peak sine wave, 13.56MHz, 50 Ohms Nominal Impedance
	CEX Output:	Female type BNC connector, 5 to 8V Peak-to-Peak, 13.56MHz into 50 Ohms
	VALVE	4-Pin Male Disk-Drive Connector
Power Monitor Scaling:	Forward Power Monitor	Monitor output is linearly proportional to 0 to 1200 Watts of forward power. Output scaling is 5.0VDC at 1200 Watts (4.16mV/Watt) or 10.0VDC at 1200 Watts (8.33mV/Watt), depending on the analog voltage range selected. (Default scaling)
	Reflected Power Monitor	Monitor output is linearly proportional to 0 to 100 Watts of reflected power. Output scaling is 5.0VDC at 150 Watts (33.3mV/Watt) or 10.0VDC at 150 Watts (66.6mV/Watt), depending on the analog voltage range selected. (Default scaling)
Analog Setpoint Sensitivity:	In Power Control mode, analog setpoint sensitivity is 1200 Watts at 5.0VDC (4.16mV per Watt) or 1200 Watts at 10.0VDC (8.33mV per Watt), depending on the analog voltage range selected.	
Labels:	Safety:	Per customer requirements. Labels may include Hazardous Voltage, Heavy Object

R1001W Specifications

Identification: Seren IPS Inc. part number, serial number, and customer part number (optional)

Dimensions 7.00 (133.35) High x 9.50 (241.30) Wide x 18.38 (466.85) Deep. Width
inch (mm): includes ½-Rack Mounting Brackets.
Width without ½-Rack Mounting Brackets: 8.00 (203.2)

Weight: 37 Lbs (16.8Kg)

L1001 Specifications

AC Mains	Voltage: 190-264V Single Phase.	
Input Power	There are no transformer voltage taps to configure.	
	Frequency: 47-63 HZ	
	Current: 15A Maximum.	
	Power required: 1650VA Maximum	
	Overcurrent Protection:	Rear Panel Circuit Breaker, 2x 1.5A 1/4"x1-1/4" time-delay fuses.
Power Cord Supplied	190-264V: 14/3 Type SJT, 2m length, with IEC320-C13 female connector to NEMA L6-15P plug. Seren P/N 4500910001	
Output:	Power:	High Range: 0 to 1000 Watts into 50 Ohms Low Range: 0 to 100 Watts into 50 Ohms
	Maximum Reflected Power:	100 Watts
	Frequency:	100KHz to 460KHz, 1 KHz Steps, Frequency Synthesized
	Leveling:	Forward Power, Load (Net) Power, External Feedback (RF or DC Probe)
	Frequency Stability:	0.005% Short-term
	Power Stability:	0.5% Long Term, +/- 1 Watt
	Output Impedance:	50 Ohms, +/-5 Ohms Nominal
	Metering Accuracy: (Forward Power)	+/- 1% Full Scale, +/- 1% of Reading
	Temperature Coefficient:	0.25% per °C
	Forward Power Regulation:	+/- 1% into 50 Ohms
	Load Tolerance:	No oscillation or failure into a mismatch condition.
	Protection:	Forward power limits on current, transistor power dissipation, and excessive reflected power. Unit is short-circuit and open-circuit protected. Unit is thermally protected.
	Spurious Radiation:	Designed to meet or exceed FCC requirements.

L1001 Specifications

Harmonics:	Equal to or less than -40dBc at maximum output frequency										
Noise, Hum, and Ripple:	-50dBc										
Pulsing:	0 to 1KHz, 1-Hz Steps; 0 to 100% duty cycle; 50 micro-second minimum pulse										
Environment:	<table border="0"> <tr> <td style="vertical-align: top;">Operating Temperature Ambient:</td> <td style="vertical-align: top;">0 to +40°C</td> </tr> <tr> <td style="vertical-align: top;">Operating Relative Humidity:</td> <td style="vertical-align: top;">10% to 90%, non-condensing</td> </tr> <tr> <td style="vertical-align: top;">Atmospheric Pressure, Operating:</td> <td style="vertical-align: top;">683 mBar minimum (approx 3000m above sea level)</td> </tr> <tr> <td style="vertical-align: top;">Atmospheric Pressure, Storage:</td> <td style="vertical-align: top;">585 mBar minimum (approx 4000m above sea level)</td> </tr> <tr> <td style="vertical-align: top;">Atmospheric Pressure, Transporting:</td> <td style="vertical-align: top;">480 mBar minimum (approx 5000m above sea level)</td> </tr> </table>	Operating Temperature Ambient:	0 to +40°C	Operating Relative Humidity:	10% to 90%, non-condensing	Atmospheric Pressure, Operating:	683 mBar minimum (approx 3000m above sea level)	Atmospheric Pressure, Storage:	585 mBar minimum (approx 4000m above sea level)	Atmospheric Pressure, Transporting:	480 mBar minimum (approx 5000m above sea level)
Operating Temperature Ambient:	0 to +40°C										
Operating Relative Humidity:	10% to 90%, non-condensing										
Atmospheric Pressure, Operating:	683 mBar minimum (approx 3000m above sea level)										
Atmospheric Pressure, Storage:	585 mBar minimum (approx 4000m above sea level)										
Atmospheric Pressure, Transporting:	480 mBar minimum (approx 5000m above sea level)										
Cooling:	Forced Air, 110 CFM (52 L/sec)										
Interface Connections:	<table border="0"> <tr> <td style="vertical-align: top;">Analog Interface:</td> <td style="vertical-align: top;">25 pin Female D-Sub Connector</td> </tr> <tr> <td style="vertical-align: top;">Serial Interface:</td> <td style="vertical-align: top;">9 pin Female D-Sub Connector</td> </tr> <tr> <td style="vertical-align: top;">CEX Input:</td> <td style="vertical-align: top;">Female type BNC connector, 3 to 8V Peak-to-Peak sine wave, 100-460KHz, 50 Ohms Nominal Impedance</td> </tr> <tr> <td style="vertical-align: top;">CEX Output:</td> <td style="vertical-align: top;">Female type BNC connector, 5 to 8V Peak-to-Peak, 100-460KHz into 50 Ohms</td> </tr> </table>	Analog Interface:	25 pin Female D-Sub Connector	Serial Interface:	9 pin Female D-Sub Connector	CEX Input:	Female type BNC connector, 3 to 8V Peak-to-Peak sine wave, 100-460KHz, 50 Ohms Nominal Impedance	CEX Output:	Female type BNC connector, 5 to 8V Peak-to-Peak, 100-460KHz into 50 Ohms		
Analog Interface:	25 pin Female D-Sub Connector										
Serial Interface:	9 pin Female D-Sub Connector										
CEX Input:	Female type BNC connector, 3 to 8V Peak-to-Peak sine wave, 100-460KHz, 50 Ohms Nominal Impedance										
CEX Output:	Female type BNC connector, 5 to 8V Peak-to-Peak, 100-460KHz into 50 Ohms										
Power Monitor Scaling:	<table border="0"> <tr> <td style="vertical-align: top;">Forward Power Monitor</td> <td style="vertical-align: top;">Monitor output is linearly proportional to 0 to 1000 Watts of forward power.</td> </tr> <tr> <td style="vertical-align: top;">Scaling:</td> <td style="vertical-align: top;">Output scaling is 5.0VDC at 1000 Watts (5.0mV/Watt) or 10.0VDC at 1000 Watts (10mV/Watt), depending on the analog voltage range selected. (Default scaling)</td> </tr> </table>	Forward Power Monitor	Monitor output is linearly proportional to 0 to 1000 Watts of forward power.	Scaling:	Output scaling is 5.0VDC at 1000 Watts (5.0mV/Watt) or 10.0VDC at 1000 Watts (10mV/Watt), depending on the analog voltage range selected. (Default scaling)						
Forward Power Monitor	Monitor output is linearly proportional to 0 to 1000 Watts of forward power.										
Scaling:	Output scaling is 5.0VDC at 1000 Watts (5.0mV/Watt) or 10.0VDC at 1000 Watts (10mV/Watt), depending on the analog voltage range selected. (Default scaling)										

R2001 Specifications

AC Mains	Voltage: 190-264V, Single Phase or Three Phase (specify at time of order)	
Input Power	There are no transformer voltage taps to configure.	
	Frequency:	47-63 HZ
	Current:	Single Phase: 20A Maximum Three Phase: 15A Maximum
	Power required:	3100VA Maximum
	Overcurrent Protection:	Rear Panel Circuit Breaker, 2x 1.5A 1/4"x1-1/4" time-delay fuses.
Power Cord:	Single Phase:	12/3 Type SOW, 6 foot length, with NEMA Type L6-20P locking connector
	Three Phase:	12/4 Type SOW, 6 foot length, with NEMA type L15-20P locking connector
Output:	Power:	High Range: 0 to 2000 Watts into 50 Ohms Low Range: 0 to 200 Watts into 50 Ohms
	Maximum Reflected Power:	200 Watts
	Frequency:	13.56MHz, Fixed, Crystal Controlled, or 1.7-2.1MHz, 1 KHz Steps, Frequency Synthesized
	Leveling:	Forward Power, Load (Net) Power, External Feedback (RF or DC Probe)
	RF Output Connector:	Type N, HN, or 7/16 DIN female. Customer Specified
	Frequency Stability:	0.005% Short-term
	Power Stability:	0.5% Long Term, +/- 1 Watt
	Output Impedance:	50 Ohms, +/-5 Ohms Nominal
	Metering Accuracy: (Forward Power)	+/- 1% Full Scale, +/- 1% of Reading
	Temperature Coefficient:	0.25% per °C
	Forward Power Regulation:	+/- 1% into 50 Ohms

R2001 Specifications

	Load Tolerance:	No oscillation or failure into a mismatch condition.
	Protection:	Forward power limits on current, transistor power dissipation, and excessive reflected power. Unit is short-circuit and open-circuit protected. Unit is thermally protected.
	Spurious Radiation:	Designed to meet or exceed FCC requirements.
	Harmonics:	-50dBc
	Noise, Hum, and Ripple:	-50dBc
	Pulsing:	0 to 1KHz, 1-Hz Steps; 0 to 100% duty cycle; 50 micro-second minimum pulse
Environment:	Operating Temperature Ambient:	0 to +40°C
	Operating Relative Humidity:	10% to 90%, non-condensing
	Atmospheric Pressure, Operating:	683 mBar minimum (approx 3000m above sea level)
	Atmospheric Pressure, Storage:	585 mBar minimum (approx 4000m above sea level)
	Atmospheric Pressure, Transporting:	480 mBar minimum (approx 5000m above sea level)
Cooling:	Ventilation:	Forced Air, 150 CFM, intake at sides, exhaust at rear panel. Observe specified panel clearances and mounting instructions
	Coolant Water:	Flow: 2.0 gallon/minute minimum. Inlet Temperature: +15°C minimum to +40°C maximum temperature, +22°C to +28°C recommended.
	Coolant Water Purity:	pH: Between 7 and 9 Total Chlorine: <20ppm Total Nitrate: <10ppm Total Sulfate: <100ppm Total Dissolved Solids: <250ppm Total Hardness expressed as Calcium Carbonate equivalent: <250ppm Specific Resistivity: >2500 Ohms/cm @ +25°C

R2001 Specifications

Coolant Water Fittings:	Type 3/8" N.P.T. Female threaded pipe
Coolant Water Supply Line Inside Diameter:	3/8" [9.52mm] Inside Diameter (I.D.) or larger.
Waste Heat into Coolant Water	1600 Watts (91 BTU/minute) maximum. Note: The waste heat does not peak at 2000 Watts of output power - the waste heat peaks at 50% to 80% of full power or under certain reflected power conditions.
Interlocks:	<p>External: External interlock provided for disabling RF output power</p> <p>Valve (optional): Prevents/disables RF Power output if external water valve is missing or un plugged. (standard units ignore this interlock – consult factory if valve interlock is required)</p>
Interface Connections:	<p>Analog Interface: 25 pin Female D-Sub Connector</p> <p>Serial Interface: 9 pin Female D-Sub Connector</p> <p>CEX Input: Female type BNC connector, 3 to 8V Peak-to-Peak sine wave, 13.56MHz or 1.7-2.1MHz, 50 Ohms Nominal Impedance</p> <p>CEX Output: Female type BNC connector, 5 to 8V Peak-to-Peak, 13.56MHz or 1.7-2.1MHz into 50 Ohms</p> <p>VALVE 4-Pin Male Disk-Drive Connector</p>
Power Monitor Scaling:	<p>Forward Power Monitor Monitor output is linearly proportional to 0 to 2000 Watts of forward power. Output scaling is 5.0VDC at 2000 Watts (2.5mV/Watt) or 10.0VDC at 2000 Watts (5.0mV/Watt), depending on the analog voltage range selected. (Default scaling)</p> <p>Reflected Power Monitor Monitor output is linearly proportional to 0 to 200 Watts of reflected power. Output scaling is 5.0VDC at 200 Watts (25mV/Watt) or 10.0VDC at 200 Watts (50mV/Watt), depending on the analog voltage range selected. (Default scaling)</p>

R2001 Specifications

Analog Setpoint Sensitivity: In Power Control mode, analog setpoint sensitivity is 2000 Watts at 5.0VDC (2.5mV per Watt) or 2000 Watts at 10.0VDC (5.0mV per Watt), depending on the analog voltage range selected.

Labels: Safety: Per customer requirements. Labels may include Hazardous Voltage, Heavy Object
Identification: Seren IPS Inc. part number, serial number, and customer part number (optional)

Dimensions inch (mm): 7.00 (133.35) High x 19.00 (482.60) Wide x 22.75 (577.85) Deep.
Width includes Rack Mounting Brackets.
Width without Rack Mounting Brackets: 17.00 (431.80)
Depth includes Mains Power Connection Terminal Box

Weight: 55 Lbs (24.9Kg)

R2001H Specifications

AC Mains	Voltage: 190-264V. Single Phase or Three Phase (specify at time of order)	
Input Power	There are no transformer voltage taps to configure.	
	Frequency:	47-63 HZ
	Current:	Single Phase: 25A Maximum Three Phase: 15A Maximum
	Power required:	5700VA Maximum
	Overcurrent Protection:	Rear Panel Circuit Breaker, 2x 1.5A 1/4"x1-1/4" time-delay fuses.
Power Cord:	Single Phase:	10/3 Type SOW, 6 foot length, with NEMA Type L6-30P locking connector
	Three Phase:	12/4 Type SOW, 6 foot length, with NEMA Type L15-20P locking connector
Output:	Power:	High Range: 0 to 2000 Watts into 50 Ohms Low Range: 0 to 200 Watts into 50 Ohms
	Maximum Reflected Power:	500 Watts
	Frequency:	13.56MHz, Fixed, Crystal Controlled, or 1.7-2.1MHz, 1 KHz Steps, Frequency Synthesized
	Leveling:	Forward Power, Load (Net) Power, External Feedback (RF or DC Probe)
	RF Output Connector:	Type N, HN, or 7/16 DIN female. Customer Specified
	Frequency Stability:	0.005% Short-term
	Power Stability:	0.5% Long Term, +/- 1 Watt
	Output Impedance:	50 Ohms, +/-5 Ohms Nominal
	Metering Accuracy: (Forward Power)	+/- 1% Full Scale, +/- 1% of Reading
	Temperature Coefficient:	0.25% per °C
	Forward Power Regulation:	+/- 1% into 50 Ohms

R2001H Specifications

	Load Tolerance:	No oscillation or failure into a mismatch condition.
	Protection:	Forward power limits on current, transistor power dissipation, and excessive reflected power. Unit is short-circuit and open-circuit protected. Unit is thermally protected.
	Spurious Radiation:	Designed to meet or exceed FCC requirements.
	Harmonics:	-50dBc
	Noise, Hum, and Ripple:	-50dBc
	Pulsing:	0 to 1KHz, 1-Hz Steps; 0 to 100% duty cycle; 50 micro-second minimum pulse
Environment:	Operating Temperature Ambient:	0 to +40°C
	Operating Relative Humidity:	10% to 90%, non-condensing
	Atmospheric Pressure, Operating:	683 mBar minimum (approx 3000m above sea level)
	Atmospheric Pressure, Storage:	585 mBar minimum (approx 4000m above sea level)
	Atmospheric Pressure, Transporting:	480 mBar minimum (approx 5000m above sea level)
Cooling:	Ventilation:	Forced Air, 150 CFM, intake at sides, exhaust at rear panel. Observe specified panel clearances and mounting instructions
	Coolant Water:	Flow: 3.0 gallons/minute minimum. Inlet Temperature: +15°C minimum to +40°C maximum temperature, +22°C to +28°C recommended.
	Coolant Water Purity:	pH: Between 7 and 9 Total Chlorine: <20ppm Total Nitrate: <10ppm Total Sulfate: <100ppm Total Dissolved Solids: <250ppm Total Hardness expressed as Calcium Carbonate equivalent: <250ppm Specific Resistivity: >2500 Ohms/cm @ +25°C

R2001H Specifications

Coolant Water Fittings:	Type 3/8" N.P.T. Female threaded pipe
Coolant Water Supply Line Inside Diameter:	3/8" [9.52mm] Inside Diameter (I.D.) or larger.
Waste Heat into Coolant Water	1600 Watts (91 BTU/minute) maximum Note: The waste heat does not peak at 2000 Watts of output power - the waste heat peaks at 50% to 80% of full power or under certain reflected power conditions.
Interlocks:	<p>External: External interlock provided for disabling RF output power</p> <p>Valve (optional): Prevents/disables RF Power output if external water valve is missing or un plugged. (standard units ignore this interlock – consult factory if valve interlock is required)</p>
Interface Connections:	<p>Analog Interface: 25 pin Female D-Sub Connector</p> <p>Serial Interface: 9 pin Female D-Sub Connector</p> <p>CEX Input: Female type BNC connector, 3 to 8V Peak-to-Peak sine wave, 13.56MHz or 1.7-2.1MHz, 50 Ohms Nominal Impedance</p> <p>CEX Output: Female type BNC connector, 5 to 8V Peak-to-Peak, 13.56MHz or 1.7-2.1MHz into 50 Ohms</p> <p>VALVE 4-Pin Male Disk-Drive Connector</p>
Power Monitor Scaling:	<p>Forward Power Monitor Monitor output is linearly proportional to 0 to 2000 Watts of forward power. Output scaling is 5.0VDC at 2000 Watts (2.5mV/Watt) or 10.0VDC at 2000 Watts (5.0mV/Watt), depending on the analog voltage range selected. (Default scaling)</p> <p>Reflected Power Monitor Monitor output is linearly proportional to 0 to 500 Watts of reflected power. Output scaling is 5.0VDC at 500 Watts (10mV/Watt) or 10.0VDC at 500 Watts (20mV/Watt), depending on the analog voltage range selected. (Default scaling)</p>

R2001H Specifications

Analog Setpoint Sensitivity: In Power Control mode, analog setpoint sensitivity is 2000 Watts at 5.0VDC (2.5mV per Watt) or 2000 Watts at 10.0VDC (5.0mV per Watt), depending on the analog voltage range selected.

Labels: Safety: Per customer requirements. Labels may include Hazardous Voltage, Heavy Object
Identification: Seren IPS Inc. part number, serial number, and customer part number (optional)

Dimensions inch (mm): 7.00 (133.35) High x 19.00 (482.60) Wide x 22.75 (577.85) Deep.
Width includes Rack Mounting Brackets.
Width without Rack Mounting Brackets: 17.00 (431.80)
Depth includes Mains Power Connection Terminal Box

Weight: 70 Lbs (31.74Kg)

L2001 Specifications

AC Mains	Voltage: 190-264V, Single Phase or Three Phase (specify at time of order).	
Input Power	There are no transformer voltage taps to configure.	
	Frequency:	47-63 HZ
	Current:	Single Phase: 20A Maximum Three Phase: 15A Maximum
	Power required:	3100VA Maximum
	Overcurrent Protection:	Rear Panel Circuit Breaker, 2x 1.5A 1/4"x1-1/4" time-delay fuses.
Power Cord:	Single Phase:	12/3 Type SOW, 6 foot length, with NEMA Type L6-20P locking connector
	Three Phase:	12/4 Type SOW, 6 foot length, with NEMA Type L15-20P locking connector
Output:	Power:	High Range: 0 to 2000 Watts into 50 Ohms Low Range: 0 to 200 Watts into 50 Ohms
	Maximum Reflected Power:	200 Watts
	Frequency:	100-460KHz, Variable, 1KHz steps, frequency synthesized.
	Leveling:	Forward Power, Load (Net) Power, External Feedback (RF or DC Probe)
	RF Output Connector:	Type N or HN, Customer Specified
	Frequency Stability:	0.005% Short-term
	Power Stability:	0.5% Long Term, +/- 1 Watt
	Output Impedance:	50 Ohms, +/-5 Ohms Nominal
	Metering Accuracy: (Forward Power)	+/- 1% Full Scale, +/- 1% of Reading
	Temperature Coefficient:	0.25% per °C
	Forward Power Regulation:	+/- 1% into 50 Ohms
	Load Tolerance:	No oscillation or failure into a mismatch condition.

L2001 Specifications

Protection:	Forward power limits on current, transistor power dissipation, and excessive reflected power. Unit is short-circuit and open-circuit protected. Unit is thermally protected.
Spurious Radiation:	Designed to meet or exceed FCC requirements.
Harmonics:	Equal to or less than -40dBc at maximum output frequency
Noise, Hum, and Ripple:	Equal to or less than -50dBc
Pulsing:	0 to 1KHz, 1-Hz Steps; 0 to 100% duty cycle; 50 micro-second minimum pulse
Environment:	<p>Operating Temperature Ambient: 0 to +40°C</p> <p>Operating Relative Humidity: 10% to 90%, non-condensing</p> <p>Atmospheric Pressure, Operating: 683 mBar minimum (approx 3000m above sea level)</p> <p>Atmospheric Pressure, Storage: 585 mBar minimum (approx 4000m above sea level)</p> <p>Atmospheric Pressure, Transporting: 480 mBar minimum (approx 5000m above sea level)</p>
Cooling:	<p>Ventilation: Forced Air, 150 CFM, intake at sides, exhaust at rear panel. Observe specified panel clearances and mounting instructions</p> <p>Coolant Water: Flow: 2.0 gallons/minute minimum. Inlet Temperature: +15°C minimum to +40°C maximum temperature, +22°C to +28°C recommended.</p> <p>Coolant Water Purity: pH: Between 7 and 9 Total Chlorine: <20ppm Total Nitrate: <10ppm Total Sulfate: <100ppm Total Dissolved Solids: <250ppm Total Hardness expressed as Calcium Carbonate equivalent: <250ppm Specific Resistivity: >2500 Ohms/cm @ +25°C</p> <p>Coolant Water Fittings: Type 3/8" N.P.T. Female threaded pipe</p>

L2001 Specifications

Coolant Water Supply Line Inside Diameter:	3/8" [9.52mm] Inside Diameter (I.D.) or larger.
Waste Heat into Coolant Water	<p>2000 Watts maximum.</p> <p>Note: The waste heat does not peak at 2000 Watts of output power - the waste heat peaks at 50% to 80% of full power or under certain reflected power conditions.</p>
Interlocks:	<p>External: External interlock provided for disabling RF output power</p> <p>Valve (optional): Prevents/disables RF Power output if external water valve is missing or un-plugged. (Standard units ignore this interlock – consult factory if valve interlock is required)</p>
Interface Connections:	<p>Analog Interface: 25 pin Female D-Sub Connector</p> <p>Serial Interface: 9 pin Female D-Sub Connector</p> <p>CEX Input: Female type BNC connector, 3 to 8V Peak-to-Peak sine wave, 100-460KHz, 50 Ohms Nominal Impedance</p> <p>CEX Output: Female type BNC connector, 5 to 8V Peak-to-Peak, 100-460KHz into 50 Ohms</p> <p>VALVE 4-Pin Male Disk-Drive Connector</p>
Power Monitor Scaling:	<p>Forward Power Monitor Monitor output is linearly proportional to 0 to 2000 Watts of forward power.</p> <p>Output scaling is 5.0VDC at 2000 Watts (2.5mV/Watt) or 10.0VDC at 2000 Watts (5.0mV/Watt), depending on the analog voltage range selected. (Default scaling)</p> <p>Reflected Power Monitor Monitor output is linearly proportional to 0 to 200 Watts of reflected power.</p> <p>Output scaling is 5.0VDC at 200 Watts (25mV/Watt) or 10.0VDC at 200 Watts (50mV/Watt), depending on the analog voltage range selected. (Default scaling)</p>

L2001 Specifications

Analog Setpoint Sensitivity: In Power Control mode, analog setpoint sensitivity is 2000 Watts at 5.0VDC (2.5mV per Watt) or 2000 Watts at 10.0VDC (5.0mV per Watt), depending on the analog voltage range selected.

Labels: Safety: Per customer requirements. Labels may include Hazardous Voltage, Heavy Object
Identification: Seren IPS Inc. part number, serial number, and customer part number (optional)

Dimensions inch (mm): 7.00 (133.35) High x 19.00 (482.60) Wide x 22.75 (577.85) Deep.
Width includes Rack Mounting Brackets.
Width without Rack Mounting Brackets: 17.00 (431.80)
Depth includes Mains Power Connection Terminal Box

Weight: 55 Lbs (24.9Kg)

L2001H Specifications

AC Mains	Voltage: 190-264V, Single Phase or Three Phase (specify at time of order).	
Input Power	There are no transformer voltage taps to configure.	
	Frequency:	47-63 HZ
	Current:	Single Phase: 25A Maximum Three Phase: 15A Maximum
	Power required:	5700VA Maximum
	Overcurrent Protection:	Rear Panel Circuit Breaker, 2x 1.5A 1/4"x1-1/4" time-delay fuses.
Power Cord:	Single Phase:	10/3 Type SOW, 6 foot length, with NEMA Type L6-30P locking connector
	Three Phase:	12/4 Type SOW, 6 foot length, with NEMA Type L15-20P locking connector
Output:	Power:	High Range: 0 to 2000 Watts into 50 Ohms Low Range: 0 to 200 Watts into 50 Ohms
	Maximum Reflected Power:	500 Watts
	Frequency:	100-460KHz, Variable, 1KHz steps, frequency synthesized.
	Leveling:	Forward Power, Load (Net) Power, External Feedback (RF or DC Probe)
	RF Output Connector:	Type N or HN, Customer Specified
	Frequency Stability:	0.005% Short-term
	Power Stability:	0.5% Long Term, +/- 1 Watt
	Output Impedance:	50 Ohms, +/-5 Ohms Nominal
	Metering Accuracy: (Forward Power)	+/- 1% Full Scale, +/- 1% of Reading
	Temperature Coefficient:	0.25% per °C
	Forward Power Regulation:	+/- 1% into 50 Ohms
	Load Tolerance:	No oscillation or failure into a mismatch condition.

L2001H Specifications

Protection:	Forward power limits on current, transistor power dissipation, and excessive reflected power. Unit is short-circuit and open-circuit protected. Unit is thermally protected.
Spurious Radiation:	Designed to meet or exceed FCC requirements.
Harmonics:	Equal to or less than -40dBc at maximum output frequency
Noise, Hum, and Ripple:	Equal to or less than -50dBc
Pulsing:	0 to 1KHz, 1-Hz Steps; 0 to 100% duty cycle; 50 micro-second minimum pulse
Environment:	<p>Operating Temperature Ambient: 0 to +40°C</p> <p>Operating Relative Humidity: 10% to 90%, non-condensing</p> <p>Atmospheric Pressure, Operating: 683 mBar minimum (approx 3000m above sea level)</p> <p>Atmospheric Pressure, Storage: 585 mBar minimum (approx 4000m above sea level)</p> <p>Atmospheric Pressure, Transporting: 480 mBar minimum (approx 5000m above sea level)</p>
Cooling:	<p>Ventilation: Forced Air, 150 CFM, intake at sides, exhaust at rear panel. Observe specified panel clearances and mounting instructions</p> <p>Coolant Water: Flow: 2.0 gallons/minute minimum. Inlet Temperature: +15°C minimum to +40°C maximum temperature, +22°C to +28°C recommended.</p> <p>Coolant Water Purity: pH: Between 7 and 9 Total Chlorine: <20ppm Total Nitrate: <10ppm Total Sulfate: <100ppm Total Dissolved Solids: <250ppm Total Hardness expressed as Calcium Carbonate equivalent: <250ppm Specific Resistivity: >2500 Ohms/cm @ +25°C</p> <p>Coolant Water Fittings: Type 3/8" N.P.T. Female threaded pipe</p>

L2001H Specifications

Coolant Water Supply Line Inside Diameter:	3/8" [9.52mm] Inside Diameter (I.D.) or larger.
Waste Heat into Coolant Water	<p>2000 Watts maximum.</p> <p>Note: The waste heat does not peak at 2000 Watts of output power - the waste heat peaks at 50% to 80% of full power or under certain reflected power conditions.</p>
Interlocks:	<p>External: External interlock provided for disabling RF output power</p> <p>Valve (optional): Prevents/disables RF Power output if external water valve is missing or un-plugged. (Standard units ignore this interlock – consult factory if valve interlock is required)</p>
Interface Connections:	<p>Analog Interface: 25 pin Female D-Sub Connector</p> <p>Serial Interface: 9 pin Female D-Sub Connector</p> <p>CEX Input: Female type BNC connector, 3 to 8V Peak-to-Peak sine wave, 100-460KHz, 50 Ohms Nominal Impedance</p> <p>CEX Output: Female type BNC connector, 5 to 8V Peak-to-Peak, 100-460KHz into 50 Ohms</p> <p>VALVE: 4-Pin Male Disk-Drive Connector</p>
Power Monitor Scaling:	<p>Forward Power Monitor: Monitor output is linearly proportional to 0 to 2000 Watts of forward power.</p> <p>Output scaling is 5.0VDC at 2000 Watts (2.5mV/Watt) or 10.0VDC at 2000 Watts (5.0mV/Watt), depending on the analog voltage range selected. (Default scaling)</p> <p>Reflected Power Monitor: Monitor output is linearly proportional to 0 to 500 Watts of reflected power.</p> <p>Output scaling is 5.0VDC at 500 Watts (10mV/Watt) or 10.0VDC at 500 Watts (20mV/Watt), depending on the analog voltage range selected. (Default scaling)</p>

L2001H Specifications

Analog Setpoint Sensitivity: In Power Control mode, analog setpoint sensitivity is 2000 Watts at 5.0VDC (2.5mV per Watt) or 2000 Watts at 10.0VDC (5.0mV per Watt), depending on the analog voltage range selected.

Labels: Safety: Per customer requirements. Labels may include Hazardous Voltage, Heavy Object
 Identification: Seren IPS Inc. part number, serial number, and customer part number (optional)

Dimensions inch (mm): 7.00 (133.35) High x 19.00 (482.60) Wide x 22.75 (577.85) Deep.
 Width includes Rack Mounting Brackets.
 Width without Rack Mounting Brackets: 17.00 (431.80)
 Depth includes Mains Power Connection Terminal Box

Weight: 70 Lbs (31.74Kg)

R3001 Specifications

AC Mains	Voltage: 190-264V. Single Phase or Three Phase (specify at time of order)	
Input Power	There are no transformer voltage taps to configure.	
	Frequency:	47-63 HZ
	Current:	Single Phase: 25A Maximum Three Phase: 15A Maximum
	Power required:	5700VA Maximum
	Overcurrent Protection:	Rear Panel Circuit Breaker, 2x 1.5A 1/4"x1-1/4" time-delay fuses.
Power Cord:	Single Phase:	10/3 Type SOW, 6 foot length, with NEMA Type L6-30P locking connector
	Three Phase:	10/4 Type SOW, 6 foot length, with NEMA Type L15-20P locking connector
Output:	Power:	High Range: 0 to 3000 Watts into 50 Ohms Low Range: 0 to 300 Watts into 50 Ohms
	Maximum Reflected Power:	200 Watts
	Frequency:	13.56MHz, Fixed, Crystal Controlled, or 1.7-2.1MHz, 1 KHz Steps, Frequency Synthesized
	Leveling:	Forward Power, Load (Net) Power, External Feedback (RF or DC Probe)
	RF Output Connector:	Type HN, or 7/16 DIN female. Customer Specified
	Frequency Stability:	0.005% Short-term
	Power Stability:	0.5% Long Term, +/- 1 Watt
	Output Impedance:	50 Ohms, +/-5 Ohms Nominal
	Metering Accuracy: (Forward Power)	+/- 1% Full Scale, +/- 1% of Reading
	Temperature Coefficient:	0.25% per °C
	Forward Power Regulation:	+/- 1% into 50 Ohms

R3001 Specifications

Load Tolerance:	No oscillation or failure into a mismatch condition.
Protection:	Forward power limits on current, transistor power dissipation, and excessive reflected power. Unit is short-circuit and open-circuit protected. Unit is thermally protected.
Spurious Radiation:	Designed to meet or exceed FCC requirements.
Harmonics:	-50dBc
Noise, Hum, and Ripple:	-50dBc
Pulsing:	0 to 1KHz, 1-Hz Steps; 0 to 100% duty cycle, 50 micro-second minimum pulse
Environment:	<p>Operating Temperature Ambient: 0 to +40°C</p> <p>Operating Relative Humidity: 10% to 90%, non-condensing</p> <p>Atmospheric Pressure, Operating: 683 mBar minimum (approx 3000m above sea level)</p> <p>Atmospheric Pressure, Storage: 585 mBar minimum (approx 4000m above sea level)</p> <p>Atmospheric Pressure, Transporting: 480 mBar minimum (approx 5000m above sea level)</p>
Cooling:	<p>Ventilation: Forced Air, 150 CFM, intake at sides, exhaust at rear panel. Observe specified panel clearances and mounting instructions</p> <p>Coolant Water: Flow: 3.0 gallons/minute minimum. Inlet Temperature: +15°C minimum to +40°C maximum temperature, +22°C to +28°C recommended.</p> <p>Coolant Water Purity: pH: Between 7 and 9 Total Chlorine: <20ppm Total Nitrate: <10ppm Total Sulfate: <100ppm Total Dissolved Solids: <250ppm Total Hardness expressed as Calcium Carbonate equivalent: <250ppm Specific Resistivity: >2500 Ohms/cm @ +25°C</p>

R3001 Specifications

Coolant Water Fittings:	Type 3/8" N.P.T. Female threaded pipe
Coolant Water Supply Line Inside Diameter:	3/8" [9.52mm] Inside Diameter (I.D.) or larger.
Waste Heat into Coolant Water	2000 Watts (114 BTU/minute) maximum. Note: The waste heat does not peak at 3000 Watts of output power - the waste heat peaks at 50% to 80% of full power or under certain reflected power conditions.
Interlocks:	<p>External: External interlock provided for disabling RF output power</p> <p>Valve (optional): Prevents/disables RF Power output if external water valve is missing or un plugged. (standard units ignore this interlock – consult factory if valve interlock is required)</p>
Interface Connections:	<p>Analog Interface: 25 pin Female D-Sub Connector</p> <p>Serial Interface: 9 pin Female D-Sub Connector</p> <p>CEX Input: Female type BNC connector, 3 to 8V Peak-to-Peak sine wave, 13.56MHz or 1.7-2.1MHz, 50 Ohms Nominal Impedance</p> <p>CEX Output: Female type BNC connector, 5 to 8V Peak-to-Peak, 13.56MHz or 1.7-2.1MHz into 50 Ohms</p> <p>VALVE 4-Pin Male Disk-Drive Connector</p>
Power Monitor Scaling:	<p>Forward Power Monitor Monitor output is linearly proportional to 0 to 3000 Watts of forward power. Output scaling is 5.0VDC at 3000 Watts (1.66mV/Watt) or 10.0VDC at 3000 Watts (3.33mV/Watt), depending on the analog voltage range selected. (Default scaling)</p> <p>Reflected Power Monitor Monitor output is linearly proportional to 0 to 200 Watts of reflected power. Output scaling is 5.0VDC at 200 Watts (25mV/Watt) or 10.0VDC at 200 Watts (50mV/Watt), depending on the analog voltage range selected. (Default scaling)</p>

R3001 Specifications

Analog Setpoint Sensitivity: In Power Control mode, analog setpoint sensitivity is 3000 Watts at 5.0VDC (1.66mV per Watt) or 3000 Watts at 10.0VDC (3.33mV per Watt), depending on the analog voltage range selected.

Labels: Safety: Per customer requirements. Labels may include Hazardous Voltage, Heavy Object
Identification: Seren IPS Inc. part number, serial number, and customer part number (optional)

Dimensions inch (mm): 7.00 (133.35) High x 19.00 (482.60) Wide x 22.75 (577.85) Deep.
Width includes Rack Mounting Brackets.
Width without Rack Mounting Brackets: 17.00 (431.80)
Depth includes Mains Power Connection Terminal Box

Weight: 70 Lbs (31.74Kg)

L3001 Specifications

AC Mains	Voltage: 190-264V. Single Phase or Three Phase (specify at time of order)	
Input Power	There are no transformer voltage taps to configure.	
	Frequency:	47-63 HZ
	Current:	Single Phase: 25A Maximum Three Phase: 15A Maximum
	Power required:	5700VA Maximum
	Overcurrent Protection:	Rear Panel Circuit Breaker, 2x 1.5A 1/4"x1-1/4" time-delay fuses.
Power Cord:	Single Phase:	10/3 Type SOW, 6 foot length, with NEMA Type L6-30P locking connector
	Three Phase:	12/4 Type SOW, 6 foot length, with NEMA Type L15-20P locking connector
Output:	Power:	High Range: 0 to 3000 Watts into 50 Ohms Low Range: 0 to 300 Watts into 50 Ohms
	Maximum Reflected Power:	200 Watts
	Frequency:	100-460KHz, 1 KHz Steps, Frequency Synthesized.
	Leveling:	Forward Power, Load (Net) Power, External Feedback (RF or DC Probe)
	RF Output Connector:	Type HN, or 7/16 DIN female. Customer Specified
	Frequency Stability:	0.005% Short-term
	Power Stability:	0.5% Long Term, +/- 1 Watt
	Output Impedance:	50 Ohms, +/-5 Ohms Nominal
	Metering Accuracy: (Forward Power)	+/- 1% Full Scale, +/- 1% of Reading
	Temperature Coefficient:	0.25% per °C
	Forward Power Regulation:	+/- 1% into 50 Ohms
	Load Tolerance:	No oscillation or failure into a mismatch condition.

L3001 Specifications

Protection:	Forward power limits on current, transistor power dissipation, and excessive reflected power. Unit is short-circuit and open-circuit protected. Unit is thermally protected.										
Spurious Radiation:	Designed to meet or exceed FCC requirements.										
Harmonics:	Equal to or less than -40dBc at maximum output frequency										
Noise, Hum, and Ripple:	Equal to or less than -50dBc										
Pulsing:	0 to 1KHz, 1-Hz Steps; 0 to 100% duty cycle; 50 micro-second minimum pulse										
Environment:	<table border="0"> <tr> <td style="vertical-align: top;">Operating Temperature Ambient:</td> <td style="vertical-align: top;">0 to +40°C</td> </tr> <tr> <td style="vertical-align: top;">Operating Relative Humidity:</td> <td style="vertical-align: top;">10% to 90%, non-condensing</td> </tr> <tr> <td style="vertical-align: top;">Atmospheric Pressure, Operating:</td> <td style="vertical-align: top;">683 mBar minimum (approx 3000m above sea level)</td> </tr> <tr> <td style="vertical-align: top;">Atmospheric Pressure, Storage:</td> <td style="vertical-align: top;">585 mBar minimum (approx 4000m above sea level)</td> </tr> <tr> <td style="vertical-align: top;">Atmospheric Pressure, Transporting:</td> <td style="vertical-align: top;">480 mBar minimum (approx 5000m above sea level)</td> </tr> </table>	Operating Temperature Ambient:	0 to +40°C	Operating Relative Humidity:	10% to 90%, non-condensing	Atmospheric Pressure, Operating:	683 mBar minimum (approx 3000m above sea level)	Atmospheric Pressure, Storage:	585 mBar minimum (approx 4000m above sea level)	Atmospheric Pressure, Transporting:	480 mBar minimum (approx 5000m above sea level)
Operating Temperature Ambient:	0 to +40°C										
Operating Relative Humidity:	10% to 90%, non-condensing										
Atmospheric Pressure, Operating:	683 mBar minimum (approx 3000m above sea level)										
Atmospheric Pressure, Storage:	585 mBar minimum (approx 4000m above sea level)										
Atmospheric Pressure, Transporting:	480 mBar minimum (approx 5000m above sea level)										
Cooling:	<table border="0"> <tr> <td style="vertical-align: top;">Ventilation:</td> <td style="vertical-align: top;">Forced Air, 150 CFM, intake at sides, exhaust at rear panel. Observe specified panel clearances and mounting instructions</td> </tr> <tr> <td style="vertical-align: top;">Coolant Water:</td> <td style="vertical-align: top;">Flow: 3.0 gallons/minute minimum. Inlet Temperature: +15°C minimum to +40°C maximum temperature, +22°C to +28°C recommended.</td> </tr> <tr> <td style="vertical-align: top;">Coolant Water Purity:</td> <td style="vertical-align: top;">pH: Between 7 and 9 Total Chlorine: <20ppm Total Nitrate: <10ppm Total Sulfate: <100ppm Total Dissolved Solids: <250ppm Total Hardness expressed as Calcium Carbonate equivalent: <250ppm Specific Resistivity: >2500 Ohms/cm @ +25°C</td> </tr> <tr> <td style="vertical-align: top;">Coolant Water Fittings:</td> <td style="vertical-align: top;">Type 3/8" N.P.T. Female threaded pipe</td> </tr> </table>	Ventilation:	Forced Air, 150 CFM, intake at sides, exhaust at rear panel. Observe specified panel clearances and mounting instructions	Coolant Water:	Flow: 3.0 gallons/minute minimum. Inlet Temperature: +15°C minimum to +40°C maximum temperature, +22°C to +28°C recommended.	Coolant Water Purity:	pH: Between 7 and 9 Total Chlorine: <20ppm Total Nitrate: <10ppm Total Sulfate: <100ppm Total Dissolved Solids: <250ppm Total Hardness expressed as Calcium Carbonate equivalent: <250ppm Specific Resistivity: >2500 Ohms/cm @ +25°C	Coolant Water Fittings:	Type 3/8" N.P.T. Female threaded pipe		
Ventilation:	Forced Air, 150 CFM, intake at sides, exhaust at rear panel. Observe specified panel clearances and mounting instructions										
Coolant Water:	Flow: 3.0 gallons/minute minimum. Inlet Temperature: +15°C minimum to +40°C maximum temperature, +22°C to +28°C recommended.										
Coolant Water Purity:	pH: Between 7 and 9 Total Chlorine: <20ppm Total Nitrate: <10ppm Total Sulfate: <100ppm Total Dissolved Solids: <250ppm Total Hardness expressed as Calcium Carbonate equivalent: <250ppm Specific Resistivity: >2500 Ohms/cm @ +25°C										
Coolant Water Fittings:	Type 3/8" N.P.T. Female threaded pipe										

L3001 Specifications

Coolant Water Supply Line Inside Diameter:	3/8" [9.52mm] Inside Diameter (I.D.) or larger.
Waste Heat into Coolant Water	2000 Watts (114 BTU/minute) maximum. Note: The waste heat does not peak at 3000 Watts of output power - the waste heat peaks at 50% to 80% of full power or under certain reflected power conditions.
Interlocks:	<p>External: External interlock provided for disabling RF output power</p> <p>Valve (optional): Prevents/disables RF Power output if external water valve is missing or un plugged. (standard units ignore this interlock – consult factory if valve interlock is required)</p>
Interface Connections:	<p>Analog Interface: 25 pin Female D-Sub Connector</p> <p>Serial Interface: 9 pin Female D-Sub Connector</p> <p>CEX Input: Female type BNC connector, 3 to 8V Peak-to-Peak sine wave, 100-460KHz, 50 Ohms Nominal Impedance</p> <p>CEX Output: Female type BNC connector, 5 to 8V Peak-to-Peak, 100-460KHz into 50 Ohms</p> <p>VALVE: 4-Pin Male Disk-Drive Connector</p>
Power Monitor Scaling:	<p>Forward Power Monitor: Monitor output is linearly proportional to 0 to 3000 Watts of forward power. Output scaling is 5.0VDC at 3000 Watts (1.66mV/Watt) or 10.0VDC at 3000 Watts (3.33mV/Watt), depending on the analog voltage range selected. (Default scaling)</p> <p>Reflected Power Monitor: Monitor output is linearly proportional to 0 to 200 Watts of reflected power. Output scaling is 5.0VDC at 200 Watts (25mV/Watt) or 10.0VDC at 200 Watts (50mV/Watt), depending on the analog voltage range selected. (Default scaling)</p>

L3001 Specifications

Analog Setpoint Sensitivity: In Power Control mode, analog setpoint sensitivity is 3000 Watts at 5.0VDC (1.66mV per Watt) or 3000 Watts at 10.0VDC (3.33mV per Watt), depending on the analog voltage range selected.

Labels: Safety: Per customer requirements. Labels may include Hazardous Voltage, Heavy Object
Identification: Seren IPS Inc. part number, serial number, and customer part number (optional)

Dimensions inch (mm): 7.00 (133.35) High x 19.00 (482.60) Wide x 22.75 (577.85) Deep.
Width includes Rack Mounting Brackets.
Width without Rack Mounting Brackets: 17.00 (431.80)
Depth includes Mains Power Connection Terminal Box

Weight: 70 Lbs (31.74Kg)

R5001 Specifications

AC Mains	Voltage: 190-264V. Three Phase	
Input Power	There are no transformer voltage taps to configure.	
	Frequency:	47-63 HZ
	Current:	25A Maximum
	Power required:	5700VA Maximum
	Overcurrent Protection:	Rear Panel Circuit Breaker, 2x 1.5A 1/4"x1-1/4" time-delay fuses.
Power Cord:	10/4 Type SOW, 6 foot length, with NEMA Type L15-30P locking connector	
Output:	Power:	High Range: 0 to 5000 Watts into 50 Ohms Low Range: 0 to 500 Watts into 50 Ohms
	Maximum Reflected Power:	500 Watts
	Frequency:	13.56MHz, Fixed, Crystal Controlled, or 1.7-2.1MHz, 1 KHz Steps, Frequency Synthesized
	Leveling:	Forward Power, Load (Net) Power, External Feedback (RF or DC Probe)
	RF Output Connector:	Type 7/16 DIN, or LC female. Customer Specified
	Frequency Stability:	0.005% Short-term
	Power Stability:	0.5% Long Term, +/- 1 Watt
	Output Impedance:	50 Ohms, +/-5 Ohms Nominal
	Metering Accuracy: (Forward Power)	+/- 1% Full Scale, +/- 1% of Reading
	Temperature Coefficient:	0.25% per °C
	Forward Power Regulation:	+/- 1% into 50 Ohms
	Load Tolerance:	No oscillation or failure into a mismatch condition.
	Protection:	Forward power limits on current, transistor power dissipation, and excessive reflected power. Unit is short-circuit and open-circuit protected. Unit is thermally protected.

R5001 Specifications

	Spurious Radiation:	Designed to meet or exceed FCC requirements.
	Harmonics:	-50dBc
	Noise, Hum, and Ripple:	-50dBc
	Pulsing:	0 to 1KHz, 1-Hz Steps; 0 to 100% duty cycle; 50 micro-second minimum pulse
Environment:	Operating Temperature Ambient:	0 to +40°C
	Operating Relative Humidity:	10% to 90%, non-condensing
	Atmospheric Pressure, Operating:	683 mBar minimum (approx 3000m above sea level)
	Atmospheric Pressure, Storage:	585 mBar minimum (approx 4000m above sea level)
	Atmospheric Pressure, Transporting:	480 mBar minimum (approx 5000m above sea level)
Cooling:	Ventilation:	Forced Air, 150 CFM, intake at sides, exhaust at rear panel. Observe specified panel clearances and mounting instructions
	Coolant Water:	Flow: 5.0 gallons/minute minimum. Inlet Temperature: +15°C minimum to +40°C maximum temperature, +22°C to +28°C recommended.
	Coolant Water Purity:	pH: Between 7 and 9 Total Chlorine: <20ppm Total Nitrate: <10ppm Total Sulfate: <100ppm Total Dissolved Solids: <250ppm Total Hardness expressed as Calcium Carbonate equivalent: <250ppm Specific Resistivity: >2500 Ohms/cm @ +25°C
	Coolant Water Fittings:	Type 3/8" N.P.T. Female threaded pipe
	Coolant Water Supply Line Inside Diameter:	3/8" [9.52mm] Inside Diameter (I.D.) or larger.

R5001 Specifications

Waste Heat into Coolant Water	3000 Watts maximum.	Note: The waste heat does not peak at 5000 Watts of output power - the waste heat peaks at 50% to 80% of full power or under certain reflected power conditions.
Interlocks:	External:	External interlock provided for disabling RF output power
	Valve (optional):	Prevents/disables RF Power output if external water valve is missing or un plugged. (standard units ignore this interlock – consult factory if valve interlock is required)
Interface Connections:	Analog Interface:	25 pin Female D-Sub Connector
	Serial Interface:	9 pin Female D-Sub Connector
	CEX Input:	Female type BNC connector, 3 to 8V Peak-to-Peak sine wave, 13.56MHz or 1.7-2.1MHz, 50 Ohms Nominal Impedance
	CEX Output:	Female type BNC connector, 5 to 8V Peak-to-Peak, 13.56MHz or 1.7-2.1MHz into 50 Ohms
	VALVE	4-Pin Male Disk-Drive Connector
Power Monitor Scaling:	Forward Power Monitor	Monitor output is linearly proportional to 0 to 5000 Watts of forward power. Output scaling is 5.0VDC at 5000 Watts (1.0mV/Watt) or 10.0VDC at 5000 Watts (2.0mV/Watt), depending on the analog voltage range selected. (Default scaling)
	Reflected Power Monitor	Monitor output is linearly proportional to 0 to 500 Watts of reflected power. Output scaling is 5.0VDC at 500 Watts (10mV/Watt) or 10.0VDC at 500 Watts (20mV/Watt), depending on the analog voltage range selected. (Default scaling)

R5001 Specifications

Analog Setpoint Sensitivity: In Power Control mode, analog setpoint sensitivity is 5000 Watts at 5.0VDC (1.0mV per Watt) or 5000 Watts at 10.0VDC (2.0mV per Watt), depending on the analog voltage range selected.

Labels: Safety: Per customer requirements. Labels may include Hazardous Voltage, Heavy Object
Identification: Seren IPS Inc. part number, serial number, and customer part number (optional)

Dimensions inch (mm): 8.75 (222.25) High x 19.00 (482.60) Wide x 26.63 (660.4) Deep.
Width includes Rack Mounting Brackets.
Width without Rack Mounting Brackets: 17.00 (431.80)
Depth includes Mains Power Connection Terminal Box

Weight: 80 Lbs (36.28Kg)

Physical Dimensions

Models R101, R101MKII, R301, R301MKII, L301, L301MKII

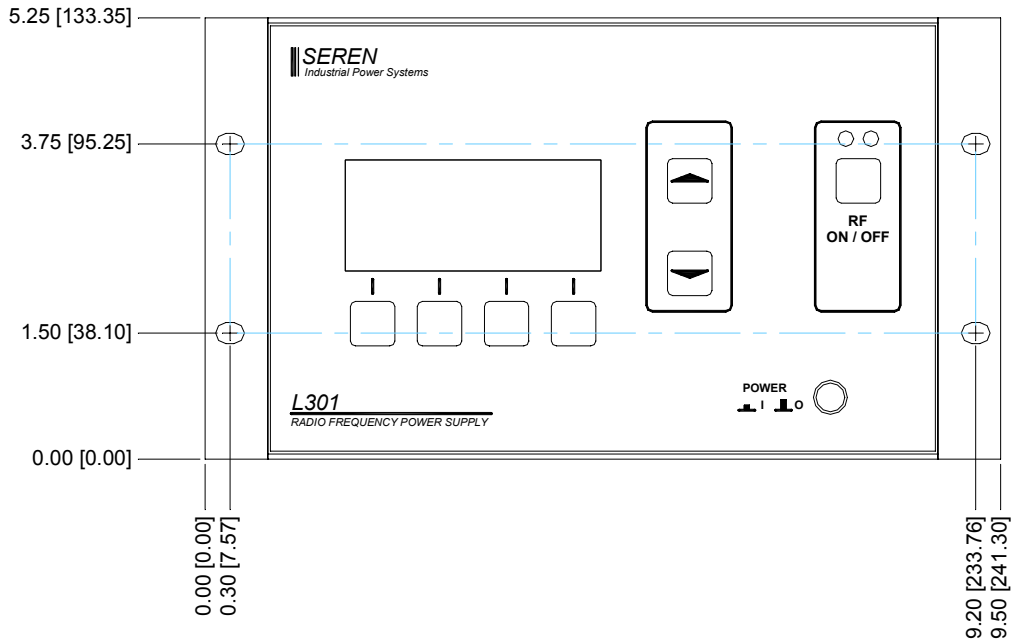

Front View, R101, R101MKII, R301, R301MKII, L301, L301MKII RF Power Supply
 Model L301 shown. Dimensions in Inch [mm]

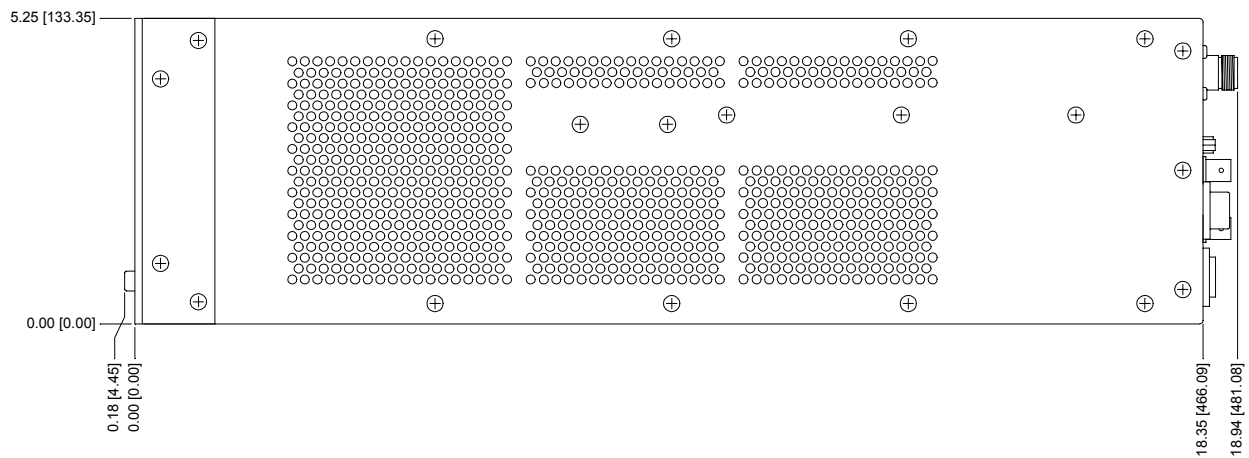

Side View, R101, R101MKII, R301, R301MKII, L301, MKII RF Power Supply
 Dimensions in Inch [mm]

Physical Dimensions: Models R101, R101MKII, R301, R301MKII, L301, L301MKII

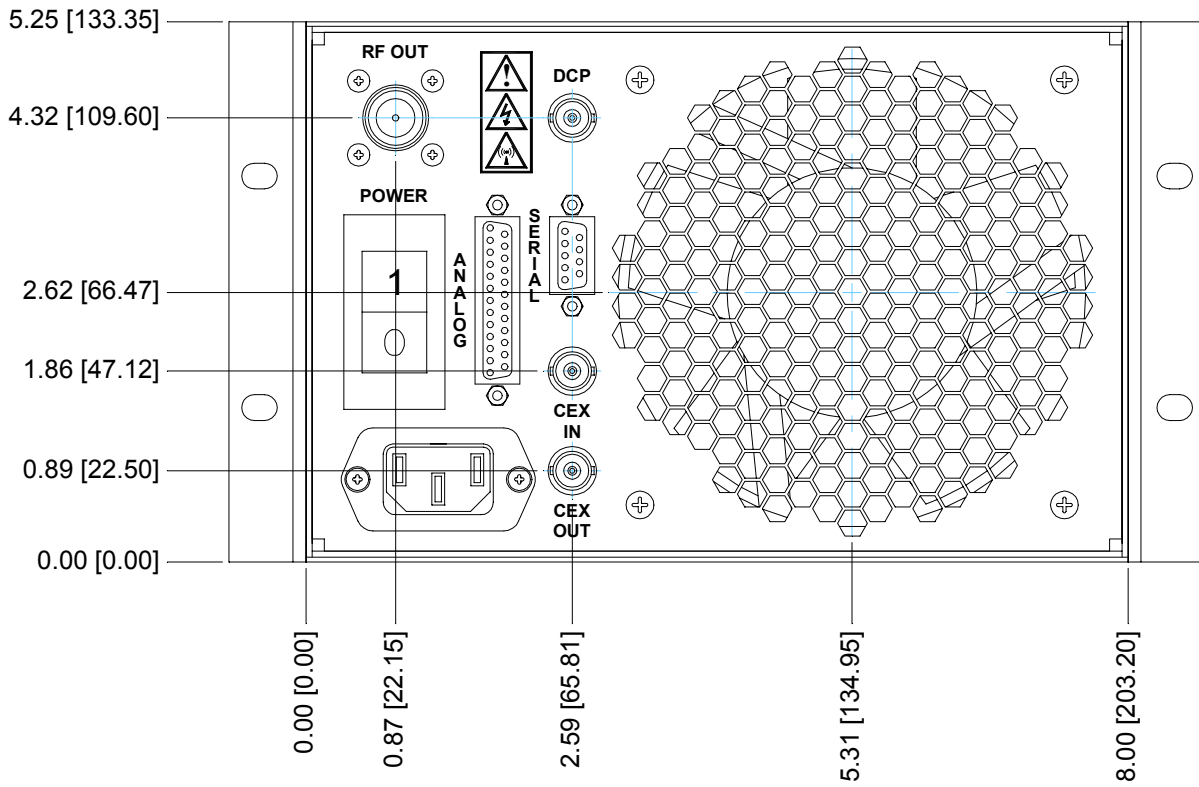

Rear View, R101, R101MKII, R301, R301MKII, L301, L301MKII RF Power Supply
 Dimensions in Inch [mm]

Physical Dimensions: Models R601, L601, R1001, R1001W, L1001

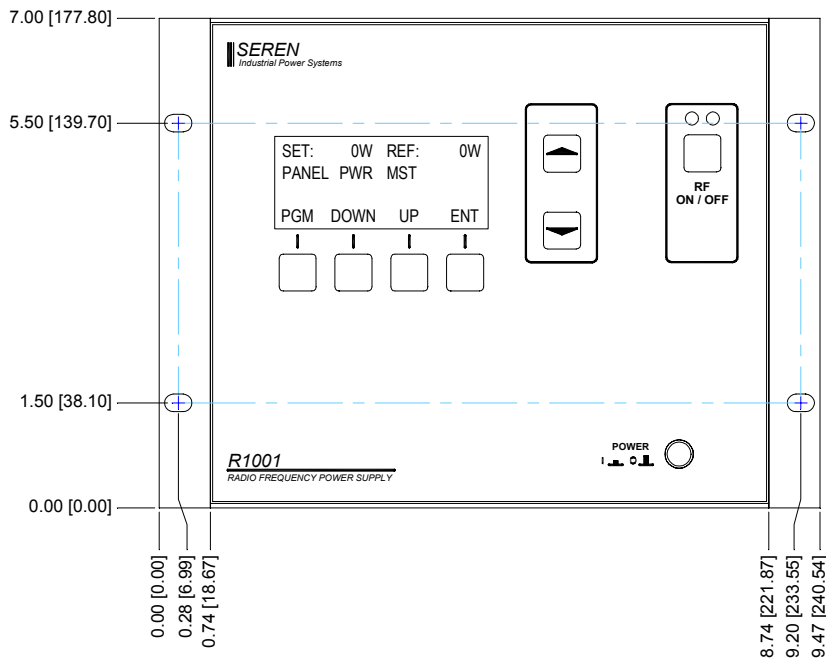

Front View, R601, L601, R1001, R1001W, L1001,
Model R1001 shown

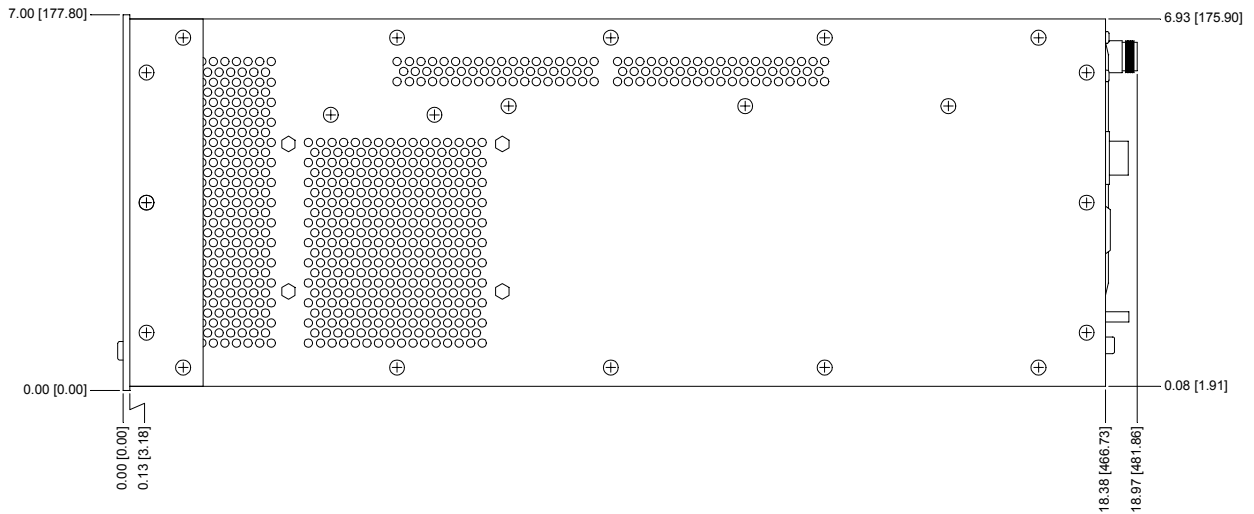

Side View, R601, L601, R1001, R1001W, L1001

Physical Dimensions: Models R601, L601, R1001, R1001W, L1001

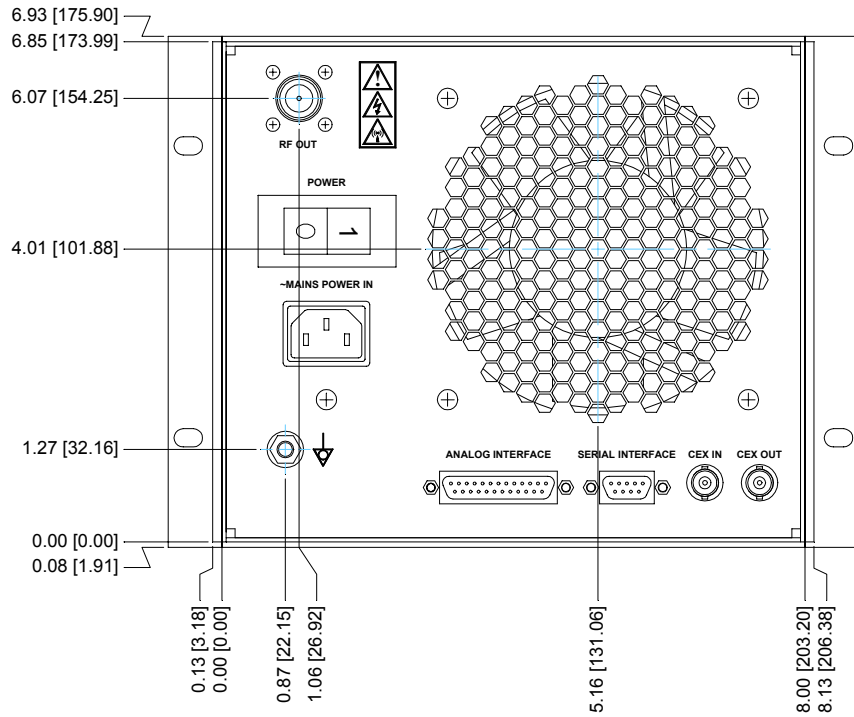

Rear View, R601, L601, R1001, L1001

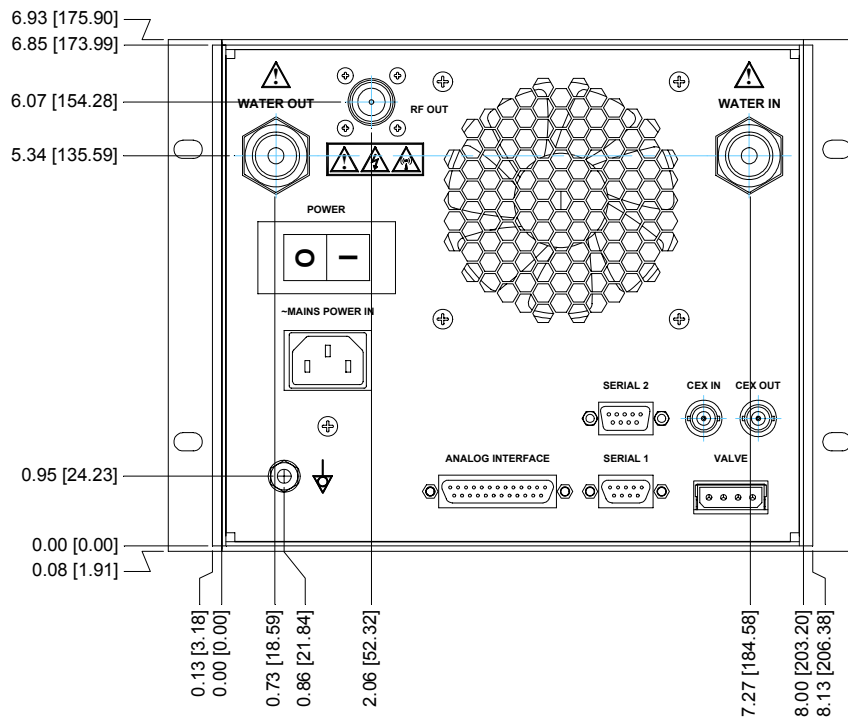

Rear View, R1001W

Physical Dimensions: Models R2001, R2001H, L2001, L2001H, R3001, L3001

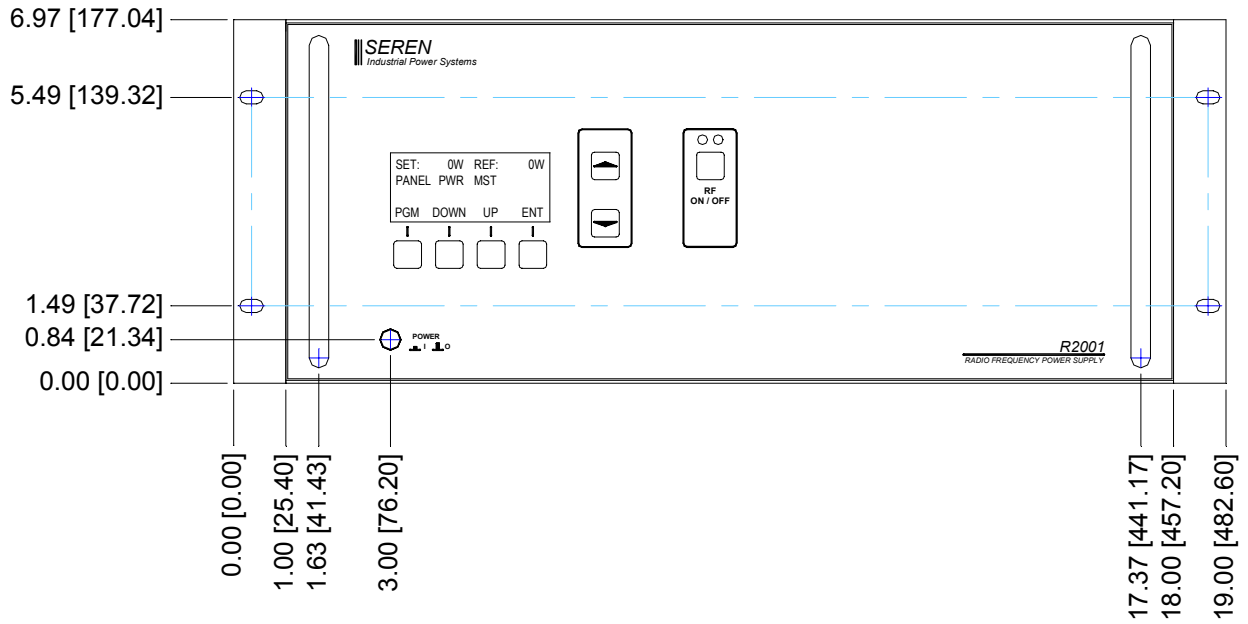

Front View, R2001, R2001H, L2001, L2001H, R3001, L3001
Model R2001 shown

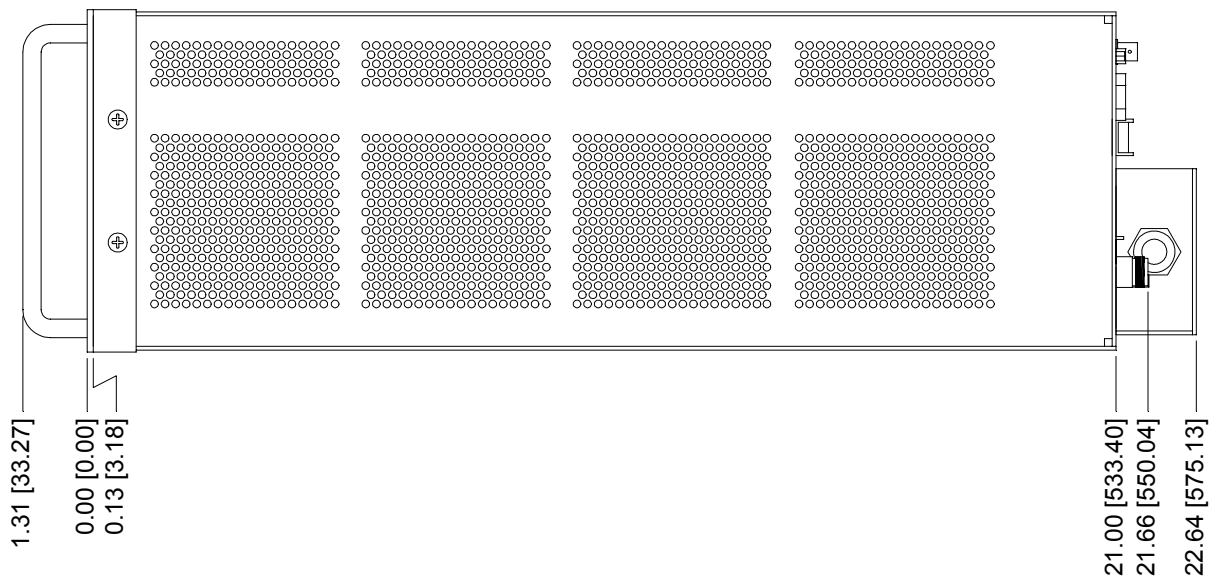

Side View, R2001, R2001H, L2001, L2001H, R3001, L3001

Physical Dimensions: Models R2001, R2001H, L2001, L2001H, R3001, L3001

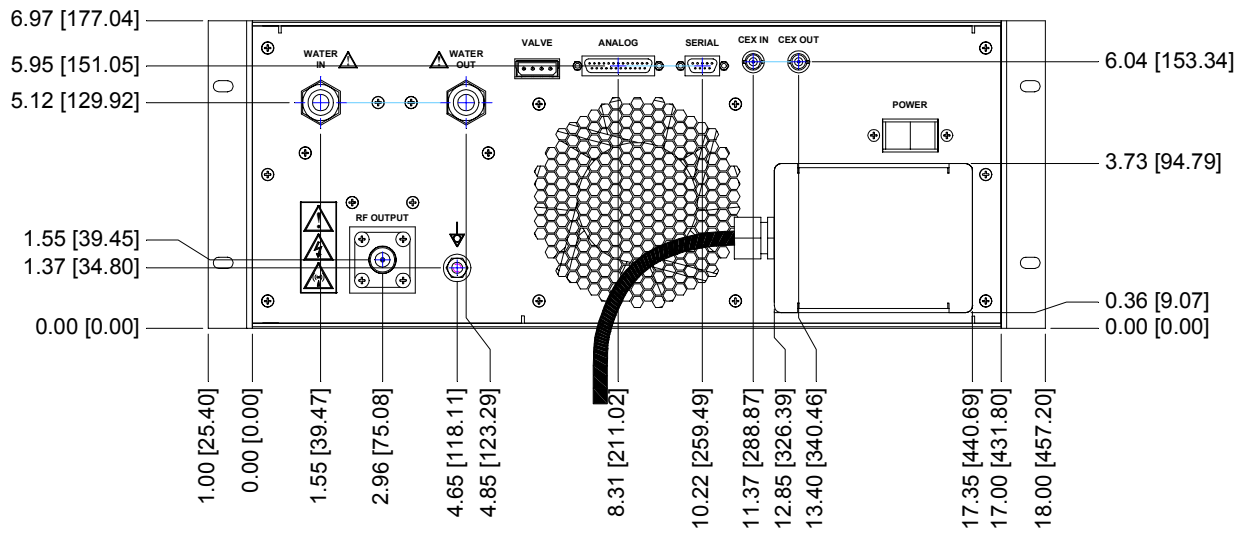

Rear View, R2001, R2001H, L2001, L2001H, R3001, L3001

Physical Dimensions: Model R5001

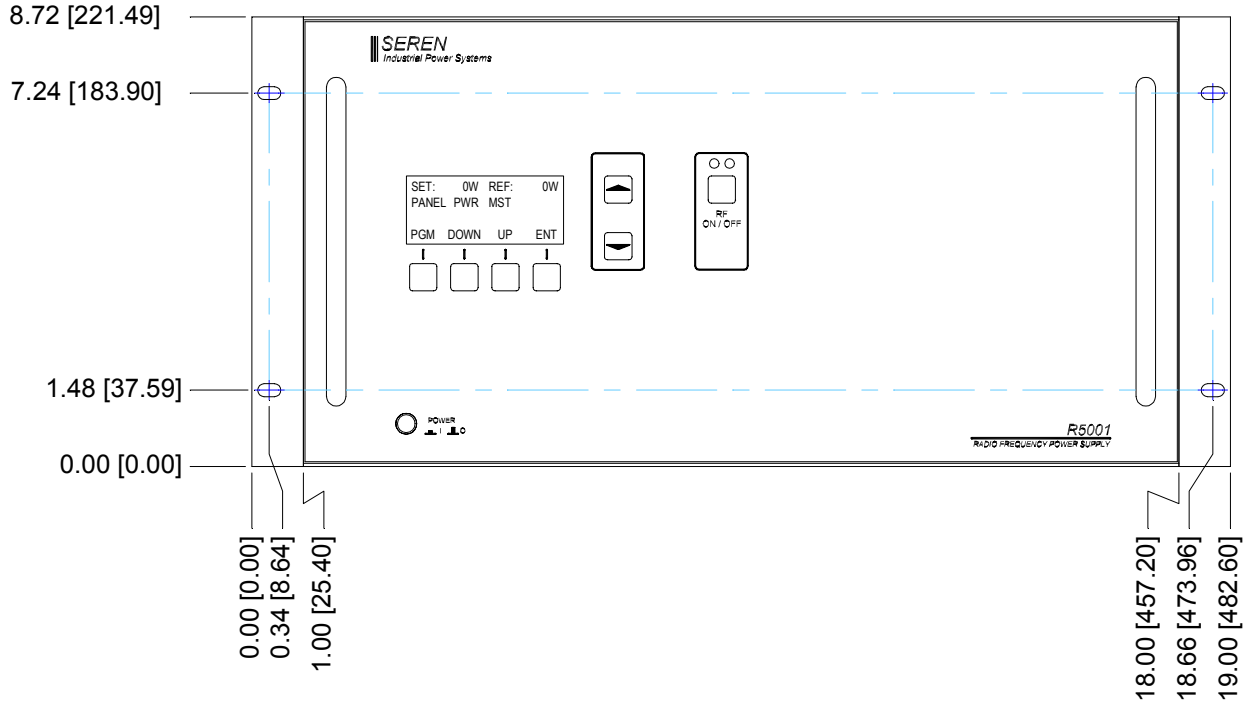

Front View, R5001

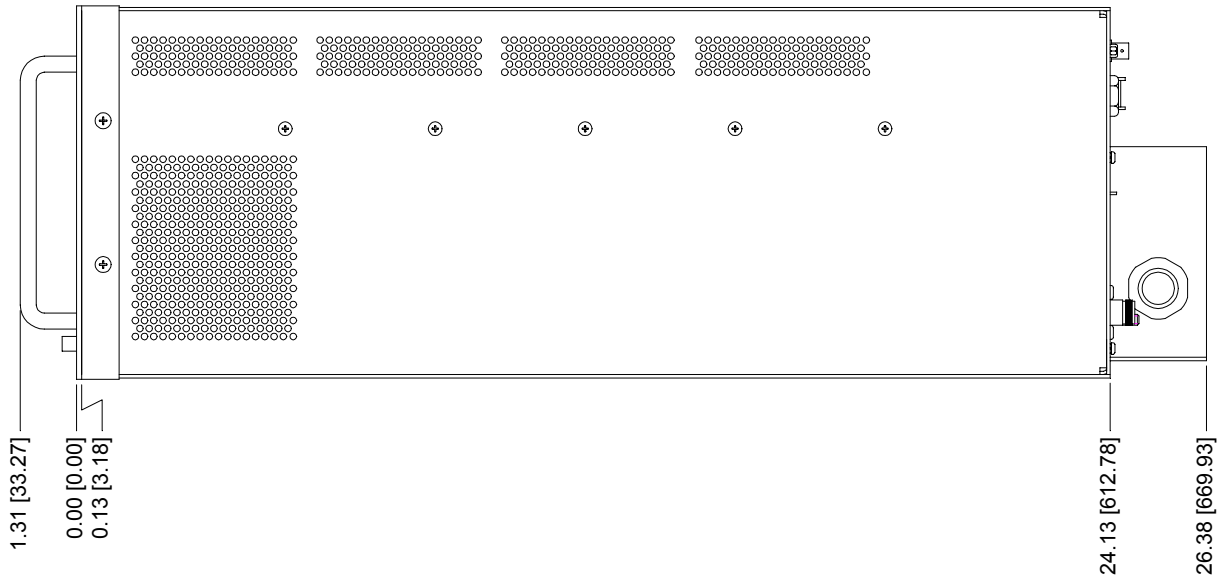

Side View, R5001

Physical Dimensions: Model R5001

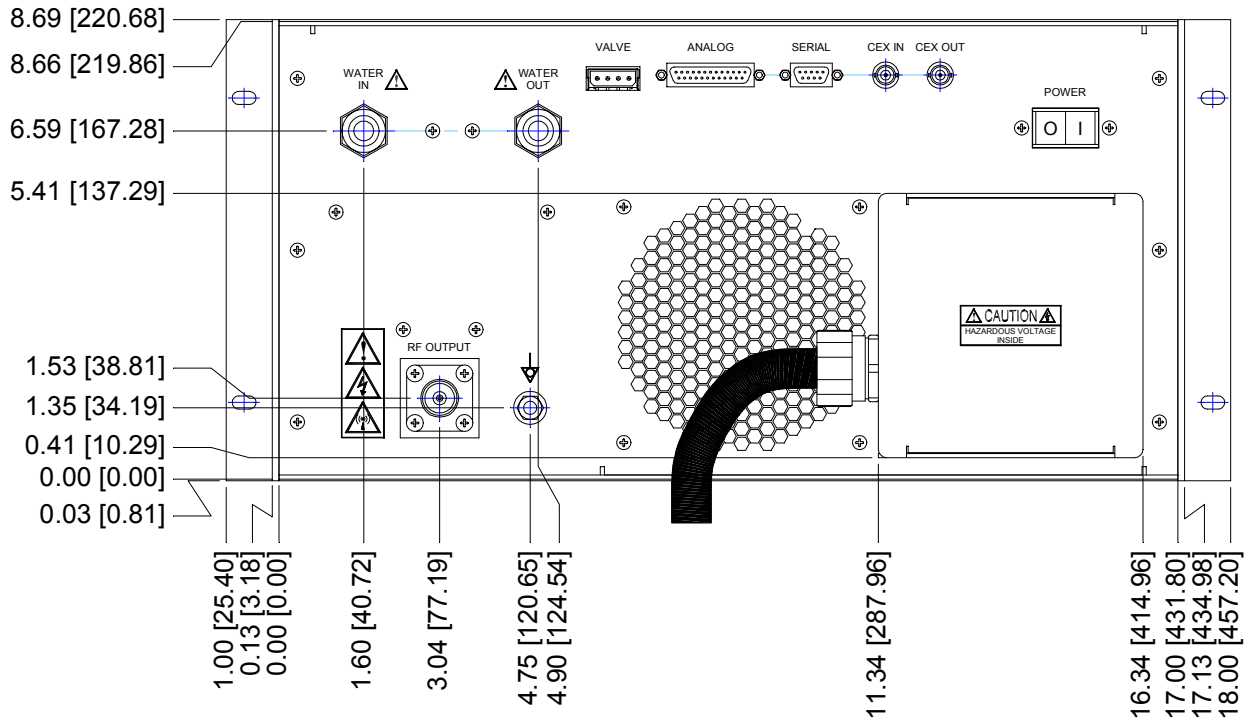

Rear View, R5001

Agency Compliance Information

R101, R101MKII, L101, R301, R301MKII, L301, L301MKII, R601, L601, R1001, L1001

Declaration of Conformity (CE)
In accordance with ISO/IEC Guide 22

Supplier: Seren IPS Inc.

Address: 1717 Gallagher Drive
Vineland, NJ, 08360
USA

European Representative: RF Industries Ltd.
Nork Works
Nork Gardens,
Banstead, Surrey, SM7 1NZ
United Kingdom

Product: **RF Power Supply Models**
R101, R101MKII, L101, R301, R301MKII,
L301, L301MKII, R601, L601, R1001, L1001

The product described above is in conformity with Essential Health and Safety Requirements of the Low Voltage Directive (LVD - 73/23/EEC) as amended and with the Electromagnetic Compatibility Directive (EMC – 89/336/EEC) as amended.

Low Voltage Directive 73/23/EEC

EN 60204-1: 1997 Safety of Machinery – General Requirements for Electrical Equipment of Machines

Electromagnetic Compatibility Directive 89/336/EEC

EN 61326:1997 +A1:1998, +A2:2001 EMC Requirements for Electrical Equipment for Measurement, Control, and Laboratory Use

EN 55011:1998/A1:1999 Generic Standard (Emissions) - Limits and Methods of Measurement of Radio Disturbance Characteristics of Industrial, Scientific and Medical (ISM) Radio-Frequency Equipment

Issued: Vineland, NJ, U.S.A. May 11, 2004

Lawrence A. Hooper

Lawrence A. Hooper
Director of Engineering

May 11, 2004

Date

R2001, R2001H, L2001, L2001H, R3001, L3001

Declaration of Conformity (CE)
In accordance with ISO/IEC Guide 22

Supplier: Seren IPS Inc.

Address: 1717 Gallagher Drive
Vineland, NJ, 08360
USA

European Representative: RF Industries Ltd.
Nork Works
Nork Gardens,
Banstead, Surrey, SM7 1NZ
United Kingdom

Product: **RF Power Supply Models**
R2001, L2001, R3001, L3001, R5001

The product described above is in conformity with Essential Health and Safety Requirements of the Low Voltage Directive (LVD - 73/23/EEC) as amended and with the Electromagnetic Compatibility Directive (EMC – 89/336/EEC) as amended.

Low Voltage Directive 73/23/EEC

EN 60204-1: 1997 Safety of Machinery – General Requirements for Electrical Equipment of Machines

Electromagnetic Compatibility Directive 89/336/EEC

EN 61326:1997 +A1:1998, +A2:2001 EMC Requirements for Electrical Equipment for Measurement, Control, and Laboratory Use

EN 55011:1998/A1:1999 Generic Standard (Emissions) - Limits and Methods of Measurement of Radio Disturbance Characteristics of Industrial, Scientific and Medical (ISM) Radio-Frequency Equipment

Issued: Vineland, NJ, U.S.A. August 12, 2004

Lawrence A. Hooper

August 12, 2004

Lawrence A. Hooper
Director of Engineering

Date

Semiconductor Equipment and Materials International (SEMI) Compliance

SEMI Safety, S2, and S8 compliance testing was conducted by an independent laboratory on representative samples of the R1001 product family and the R2001 Product family. Reproducing the laboratory reports here is beyond the scope of this document. The laboratory reports are furnished upon request. Laboratory and report references are listed below.

Laboratory:

TUV Rheinland Of North America, Inc.
North American Headquarters
12 Commerce Road
Newtown, CT 06470
Telephone: 203-426-0888, Fax: 203-426-4009
Web: www.tuv.com E-Mail: info-new@us.tuv.com

Laboratory Reports:

R1001 Product Family (Models R101,R101MKII,L101,R301,R301MKII, L301,
L301MKII, R600, L600, R1001, R1001W, L1001)

SEMI Safety EN60204-1:1997, TUV Rheinland Report number: 30470472.001
SEMI S2-0703 Evaluation Report: Environmental, Health, and Safety Guidelines
for Semiconductor Manufacturing Equipment
TUV Rheinland report number: 30470472.002

SEMI S8-0701 TUV Rheinland report number: 30470472.002

R2001 Product Family (Models R2001, R2001H, L2001, L2001H, R3001, L3001, R5001)

SEMI Safety EN60204-1:1997, TUV Rheinland Report number 30470472.004
SEMI S2-0703 Evaluation Report: Environmental, Health, and Safety Guidelines
for Semiconductor Manufacturing Equipment
TUV Rheinland report number: 30470472.003

SEMI S8-0701 TUV Rheinland report number: 30470472.002

SEREN 1 Year Limited Warranty

SEREN IPS Inc. products are warranted to the original purchaser against defects in material and workmanship for a period of one year from the date of delivery.

SEREN IPS Inc. will repair or replace, at its option, all defective products returned freight prepaid during the warranty period, without charge, provided that there is no evidence the product has been mishandled, abused, or misapplied. Our liability under this warranty is limited to servicing, repairing, or replacing any defective products for a period of one year after delivery to the original purchaser.

If warranty service is required, the equipment must be returned, transportation charges prepaid, to our factory or authorized service depot. In the case of misuse, abnormal operating conditions, or other non-warranty work, a repair cost estimate will be submitted for approval before work is started.

WHAT THE WARRANTY DOES NOT COVER:

This warranty covers only defects in materials and workmanship provided by SEREN I.P.S. and does not cover equipment damage or malfunction from misuse, abuse, accident, act of God, non-SEREN I.P.S. modification or upgrade. Improper return shipping, packaging, or shipping damage is not covered. SEREN I.P.S. will not be liable for any incidental or consequential damages resulting from your use or inability to use your RF Power Supply.

IF YOU HAVE A PROBLEM

The first step is to contact your system vendor. Consult with your system vendor to determine the nature of the problem. Your system vendor knows the intimate details of how your processing system interfaces and operates with the RF Power Supply and can efficiently resolve system related problems.

If it is determined that the RF Power Supply has a problem, contact our customer service department at **1-856-205-1131**. Before you call, please be ready to provide the model of your RF Power Supply, its serial number, date of manufacture, a description of the problem, and the model and manufacturer of the processing system it is used on.

HOW IS WARRANTY SERVICE OBTAINED?

Our customer service representative will explain how to obtain service under this warranty. Please save the original packing materials in order to facilitate shipment.

Glossary of Terms

A	Amperes, a measurement unit of current
AC	Alternating Current
ANLG	Abbreviation, "Analog"
Chamber	Industry term for a vacuum chamber used in plasma processing equipment.
Common Exciter (CEX)	A method of using an external frequency source to synchronize the outputs of RF Power Supplies in a multi-power supply system.
CPU	Central Processing Unit: computer
DC	Direct Current
D-Sub	Industry term for D-Subminiature connector
Equipotential Bond Equipotential Bonding	Equipotential bonding (often referred to as grounding) is used to control RF circulating currents within a system. For regulatory purposes, it is not a "Protective Earth" or "Safety Ground", even though it may be bonded to the "Protective Earth" or "Safety Ground" within the equipment or user's facility.
Exciter	A Radio Frequency source. RF Power Supplies amplify a RF signal source. The RF frequency signal source may be internally generated or externally supplied. (see Common Exciter).
Forward Power Leveling	Using the internal Forward Power sensor as the feedback source for power leveling (regulation).
FWD	Abbreviation, "FORWARD"
KHz	Kilo Hertz, a measurement unit of frequency (1000 Hertz)
KVA	Kilo Volt-Amperes
Load (net) Power Leveling	$(\text{Forward Power}) - (\text{Reflected Power}) = \text{Net Power}$ Using the calculated Net Power as the feedback source for power leveling (regulation).
Matchbox	Industry term for an impedance matching network
MHz	Mega Hertz, a measurement unit of frequency (1,000,000 Hertz)
mV	Milli-Volts, a measurement unit of Voltage, equal to 1/1000 of a Volt.
Net Power	The difference between forward power and reflected power.

Glossary of Terms

Non-Volatile Storage	Also know as non-volatile memory. Computer memory that retains its data after power has been removed.
RF	Radio Frequency
RF Generator	Industry term for Radio Frequency Power Supply
SEMI	Industry standards organizatio: Semiconductor Equipment and Materials International
TTL	Transistor-Transistor Logic
Tuner	Industry term for an impedance matching network
VAC	Volts, Alternating Current
VDC	Volts, Direct Current
VFT	Variable Frequency Tuning. The RF power supply's CPU monitors the reflected power and adjusts the RF output frequency to minimize the reflected power. This often eliminates the need for an expensive external automatic impedance matching network. An inexpensive matching transformer (sold separately) and a VFT-capable RF power supply can be combined to form a cost-effective system solution.
VLT	Abbreviation, "VOLTAGE"
Voltage Control	Using an external DC voltage derived from the processing system as a feedback signal for power leveling (regulation)
W	Watts

Revision History:

Revision	Date	Revision Description
0.01	10/19/03	Preliminary
0.02	10/27/03	Updated Table of Contents, Analog Interface, and Technical Data Sections.
0.03	12/18/03	Deleted "A" from R301 model number, Output frequency was 100-460KHz, updated illustrations.
0.04	4/1/04	Corrected Typical Interface Connection diagram, added maximum current and inrush current to technical specifications.
0.05	11/22/04	Added descriptions of probe inverter option, updated analog interface connector to include probe inverter option, added sections "External Feedback with Probe Inverter Option" and External Feedback with SEREN IPS AT-Series Matching Network", added Programmable Parameter Reference and Programmable Parameter Detail sections, expanded problem solving chart, updated serial interface connector section. Added frequency configuration note in programmable parameters.
0.06	12/9/04	Added serial commands, updated serial connector pin-out to include RS-422 and RS-485.
0.07	5/13/05	Added Models R/L601, R/L1001, R1001W, R/L2001, R/L2001H R/L3001, R5001.
0.08	5/31/05	Corrected serial connector pin-out (RS-485-2 wire connections) & updated illustrations
0.09	6/21/05	Updated pulsing specification, updated RFENABLED* output circuit diagram
1.00	8/31/05	Formal Release
1.01	9/8/05	Minor corrections, added 3-Phase power information to technical specifications for R2001, L2001, R3001, L3001 models
1.02	9/15/05	Updated programming menu and serial commands.

Notes: